



MICOM ELECTRIC DISPENSING POT OPERATING INSTRUCTIONS

CD-WBQ22/CD-WBQ30/CD-WBQ40 CD-WBH30C/CD-WBH40C

Always follow basic safety precautions when using electrical appliances.
Read all instructions carefully.
Please keep this instruction book on hand for easy reference.

INDEX

BEFORE USE

IMPORTANT SAFEGUARDS	2
PARTS NAMES AND FUNCTIONS	4

HOW TO USE

BOIL MODE	6
DISPENSE HOT WATER	8
DISPOSE WATER	8
AUTOMATIC SHUT-OFF FUNCTION	9
REBOIL MODE	9

USEFUL FUNCTIONS:

98°C KEEP WARM MODE	10
80°C KEEP WARM MODE	10
60°C KEEP WARM MODE	11

HOW TO CHANGE THE INFORMATION SOUND	12
CAFÉ DRIP DISPENSING MODE	12
ENERGY-SAVING TIMER FUNCTION	12

CLEANING AND MAINTENANCE

CLEAN AND MAINTENANCE	14
• HOW TO REPLACE THE INNER LID GASKET	14
HOW TO PERFORM CITRIC ACID CLEANER	15
REPLACEMENT PARTS	15

BEFORE CALLING FOR SERVICE

Q&A ON PRODUCT USE	16
TROUBLESHOOTING GUIDE	16
SPECIFICATIONS	18

IMPORTANT SAFEGUARDS

Before use

These WARNINGS and CAUTIONS are intended to protect you and others from personal injury and household damage. To ensure safe operation, please follow carefully.

WARNINGS

Do not use a power source other than 220-230V (CD-WBQ22/WBQ30/WBQ40) or 220V (CD-WBH30C/WBH40C) AC.

- Use of any other power supply voltage may cause fire or electric shock.

Do not modify the product. Only a repair technician may disassemble or repair this unit.

- Attempting to do so may cause fire, electric shock or injury. Make any repair inquiries to the store you purchased the product.

Do not plug or unplug the Power Cord if your hands are wet.

- Doing so may cause electric shock or injury.

Do not touch the Steam Vent or bring your hands or face near the Steam Vent.

- Doing so may cause burns or scalding. Take special precautions with children and infants.

Do not cover the Steam Vent with anything such as a dishcloth.

- Hot water may spill out, resulting in scalds. It may also cause deformation or discoloration of the Upper Lid or breakdown of the product.

Do not allow children to use the product unsupervised. Keep it out of the reach of infants.

- Children are at risk of burns, electric shock or injury.

Do not fill over the Maximum Water Level Line.

- Overfilling may cause hot water to spill out, resulting in scalds.

Always remove the Upper Lid before disposing hot water.

- The Upper Lid may fall off and cause hot water to splash, resulting in scalds.

Do not tilt or shake the product or carry in your arms. Do not move it or drain hot water by holding the Upper Lid.

- Doing so may result in scalding by hot water spilling out from the Spout or Steam Vent, even if the Automatic Dispense Lock is on. Always use the handle when carrying.

Do not tilt the product or tip it over.

- Hot water may spill from the Spout or Steam Vent, even if the Automatic Dispense Lock is on.

Do not slam the Upper Lid when closing.

- Hot water may dispense or spill out, resulting in scalds.

Do not use the product if the Power Plug or Power Cord is damaged or if the Power Plug is loosely inserted into the electrical outlet.

- Doing so may cause electric shock, short circuit or fire.

Close the Upper Lid securely.

- Hot water may spill out when the product is overturned, resulting in scalds.

Do not remove the Upper Lid while boiling.

Do not damage the Power Cord. Do not bend, pull, twist, fold, or attempt to modify the Power Cord. Do not place it on or near high temperature surfaces or appliances, under heavy items or between objects.

- A damaged Power Cord can cause fire or electric shock.

Do not use the product as a cooler or place ice inside of it.

- Doing so may cause condensation, resulting in electric shock or breakdown of the product.

Do not allow the prongs of the Appliance Plug to become soiled with dust or come into contact with any metal objects.

- Doing so may cause electric shock, short circuit or fire.

Do not allow infants or children to put the Appliance Plug in their mouth.

- Doing so may cause electric shock or injury. Take special precautions with children and infants.

Insert the Power Plug completely and securely into the electrical outlet.

- A loosely inserted Power Plug may cause electric shock, short circuit, smoke or fire.

Use only an electrical outlet rated at 10 amperes minimum, and do not plug other devices into the same outlet.

- Plugging other devices into the same outlet may cause the electrical outlet to overheat, resulting in fire.

If the blades or surface of the Power Plug become soiled, wipe them clean.

- A dirty Power Plug may cause fire.

Do not immerse the product in water or splash it with water, and do not put it on a wet surface such as a sink.

- Doing so may cause short circuit, electric shock or malfunction.

Do not boil anything other than water.

- Attempting to boil, cook, or heat up the following items may cause bubbling or boiling over, which may cause scalding. Doing so may also cause clogging of the water route, corrosion of the Inner Container, or peeling of the Nonstick Coating.

- Milk, sake, soup, charcoal, tea bags or tea leaves.
- Instant food.
- Food and sauce pouches or foods in plastic bags.

This appliance is not intended for use by persons (including children) with reduced physical, sensory or mental capabilities, or lack of experience and knowledge, unless they have been given supervision or instruction concerning use of the appliance by a person responsible for their safety. Children should be supervised to ensure that they do not play with the appliance.

Stop using immediately if you notice any of the following symptoms indicating a malfunction or breakdown.

- Continued use of the product may cause smoke, fire, electric shocks or injury.
 - The Power Plug or Power Cord has become very hot.
 - The Power Cord is damaged or the electricity turns on and off when touched.
 - The Body is deformed or unusually hot.
 - Smoke is arising from the product or there is a burning smell.
 - Some part of the product is cracked, loose or unstable.
 - The product emits steam for at least 10 minutes continuously and does not turn to Keep Warm mode.

If any of the above occurs, unplug the product immediately and return to the store where you purchased it for check-ups and/or repairs.

CAUTIONS

Always use caution when opening the Upper Lid and avoid skin contact with steam.

- Loose water or steam may escape upon opening the Upper Lid and cause scalds.

Do not touch hot surfaces during or for a short period of time after use.

- Touching hot surfaces may cause burns. Be especially careful with metal parts such as the Inner Lid and the Inner Container.

Do not touch the Lid Lock when carrying the product.

- Doing so may cause the Upper Lid to open, resulting in injuries or scalds.

Do not use the product near walls, furniture or beneath shelving.

- Steam or heat may damage, discolor or deform walls, furniture or shelving.

Do not swivel or move the product while dispensing water.

- Hot water may splash out, resulting in scalds.

Do not place or use the product on unstable surfaces or on surfaces that are vulnerable to heat.

- Doing so may cause fire.

Do not attempt to dispense hot water while it is boiling.

- Hot water can spurt out, resulting in scalds.

Do not use other Power Cords than the one provided. Do not use the Power Cord for other appliances or under electric voltage other than 220-230V.

- Doing so may cause malfunction or fire.

Unplug the Power Plug from the outlet when the product is not in use.

- Leaving the Power Plug in an outlet may cause the insulation to become damaged, resulting in electric shock, short circuit or fire, or result in injuries or scalds.

Please allow the product to cool down before cleaning.

- Touching hot surfaces may cause burns.

Always unplug the product by holding the Power Plug, not by pulling the Power Cord.

- Pulling the Power Cord to unplug the product may cause electric shock, short circuit or fire.

Replace the Inner Lid Gasket if it becomes discolored white.

- Hot water may spill out when the product is tilted or tipped over accidentally, and may cause scalding.

If the Power Cord is damaged, it must be replaced by an appropriate cord or assembly made available by the manufacturer or its service agent.

IMPORTANT

Avoid rough handling, dropping or bumping the product.

- Doing so may cause damage or cease operation of the product.

Avoid letting steam make contact with cabinets and walls when using near or under a kitchen shelf.

- Doing so may cause discoloration or deformation.

Do not use the product near a heat source or on top of induction heating cookers.

- Doing so may cause fire, breakdown or damage of the product.

Allow the product to dry completely when storing the product in an area where it may freeze for a long period of time.

- If water left inside freeze, it may cause breakdown or malfunction.

Do not drag the product over any surface while attempting to move.

- Doing so may cause damage to surfaces such as countertops.

Do not operate the product when it is empty.

- Doing so may burn or damage the product.

Avoid using the product near a radio, TV, computer, etc.

- The product may cause interference with certain electronics.

Do not allow hot water to come into contact with the Control Panel or the Water Level Gauge.

- Doing so may cause breakdown of the product.

Do not use the product where its steam may come into contact with other electrical appliances.

- The steam may cause fire, malfunction, discoloration or deformation to other electrical appliances.

This appliance is intended to be used in household and similar applications such as;

- Staff kitchen areas in shops, offices and other working environments;
- Environments comparable to residential living rooms and kitchens;

※This appliance is not intended for use by many unspecified people for a long period of time.

● The illustrations used in this Operating Instructions may vary from the actual product you have purchased.

PARTS NAMES AND FUNCTIONS

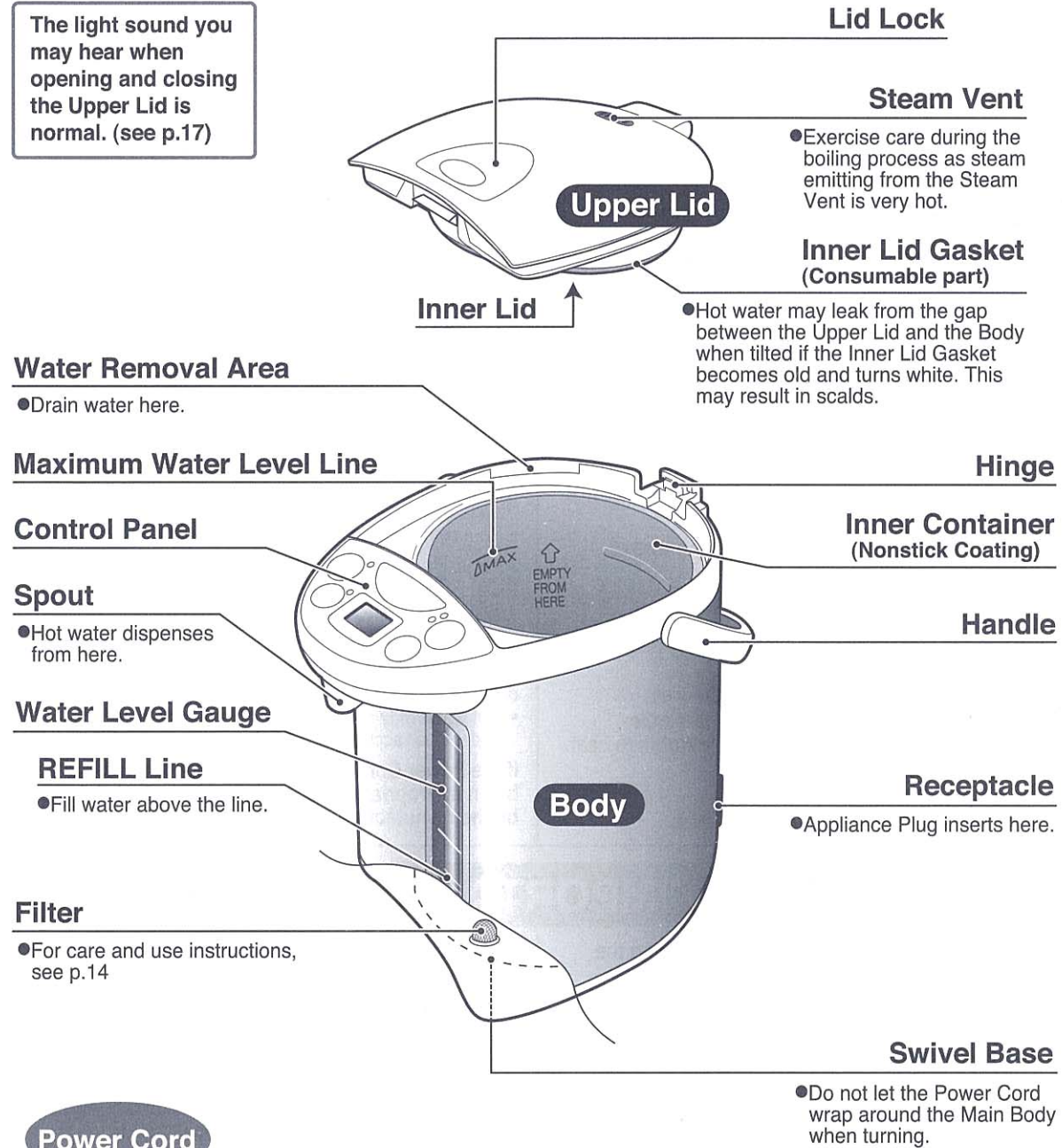

Power Cord

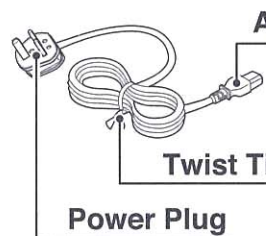

- Please remove the twist tie holding the Power Cord before use.
- Do not use the Power Cord bundled up. Doing so may cause the Power Cord to become excessively hot, resulting in malfunction.

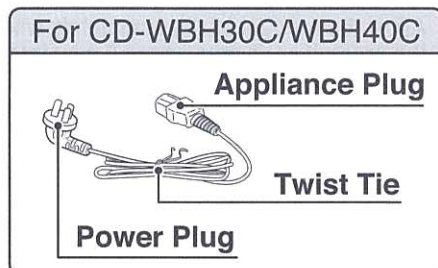

CONTROL PANEL

● Press buttons down firmly.

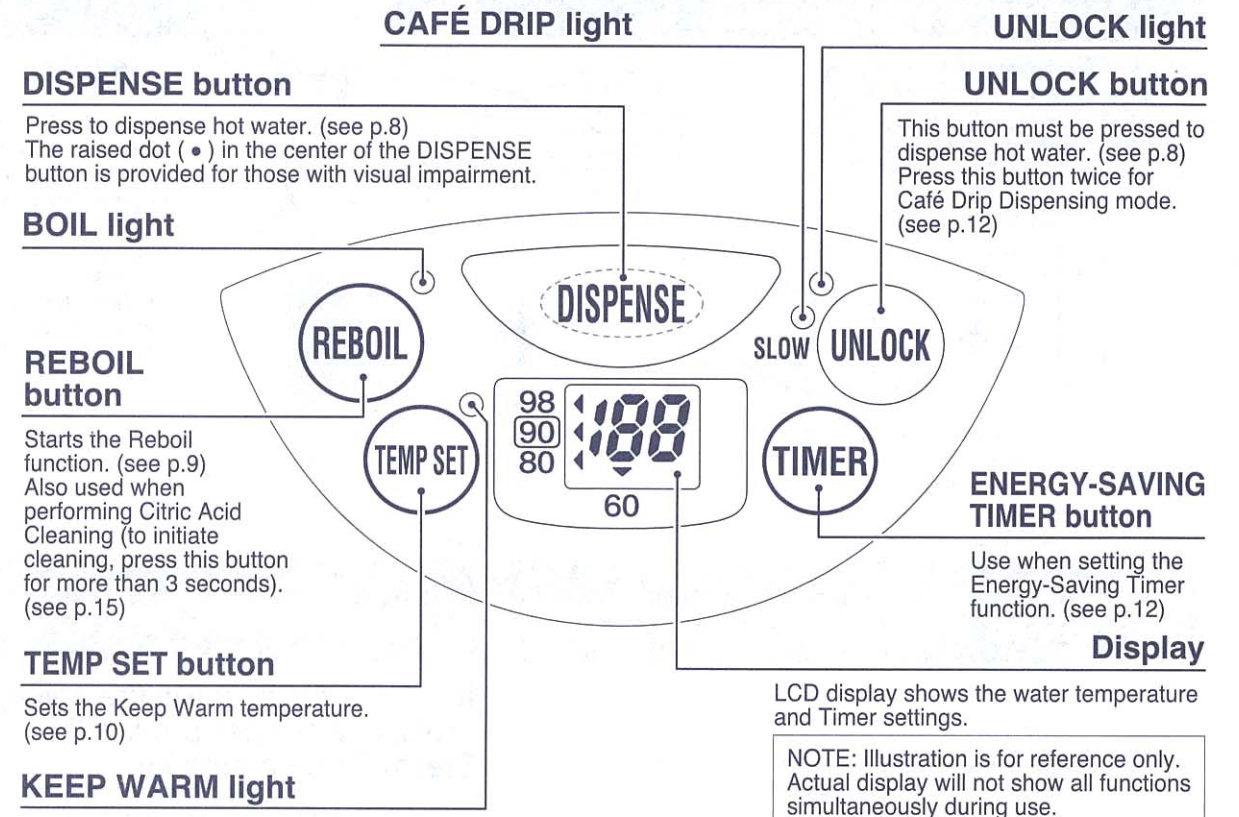

How to Open/Close the Upper Lid

- To Open**
- 1 Press the indented area of the Lid Lock with thumb.
 - 2 Pull the Lid Lock up with fingers to open the Upper Lid.
- To Close** Depress the Upper Lid until it clicks shut.

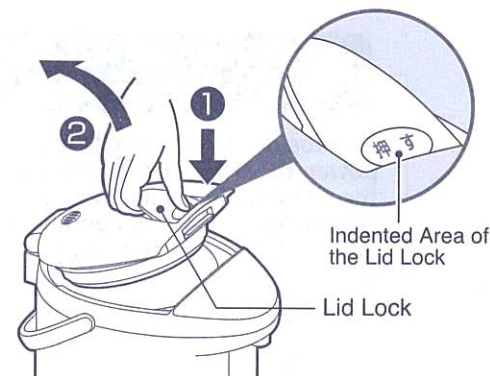

How to Detach/Attach the Upper Lid

- To Detach**
- 1 Open the Upper Lid to about a 45-degree angle.
 - 2 Press the Upper Lid Detach button.
 - 3 Pull the Upper Lid forward and up at an angle.
- To Attach** Push the Upper Lid back into place at the same angle.

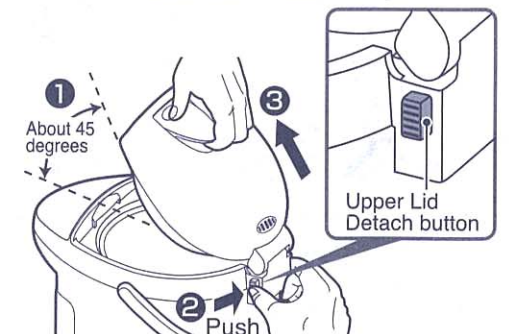

BOIL MODE

1 Open the Upper Lid and fill the Inner Container with water using a pitcher or other container.

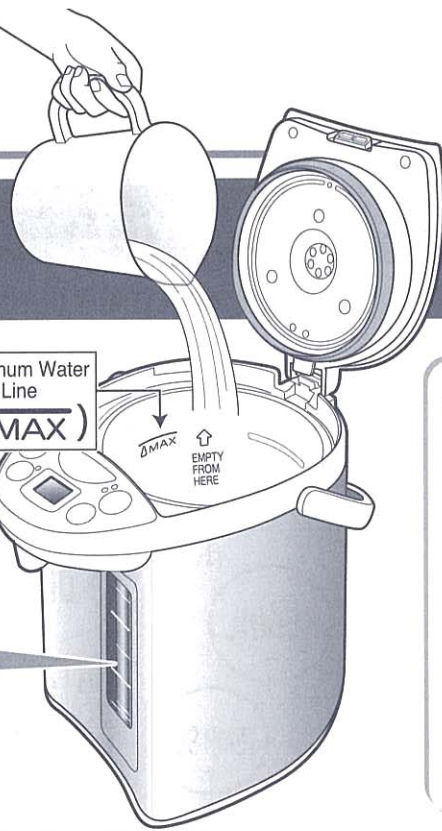

NOTE

- Do not fill the Inner Container directly from a water faucet or place the product on a wet surface such as a sink. (Exposing the heating element directly to water may cause malfunction.)



To monitor the amount of water you are filling, look at the thickness of the stripes on the Water Level Gauge.

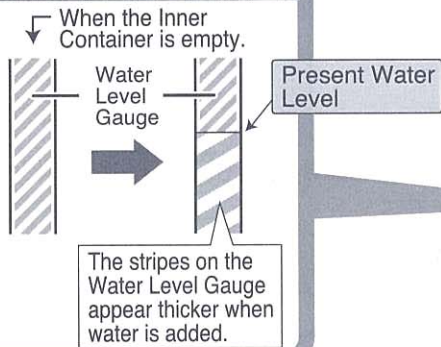

2 Close the Upper Lid and connect the Power Cord.



Close the Upper Lid securely.

To ensure safe operation while boiling and to prevent scalds if the product is overturned.

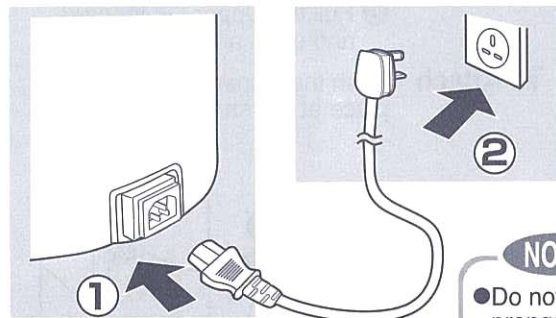

Be sure to insert the Power Cord securely.

(Otherwise, may cause electric shock, short circuit, smoke or fire.)

NOTE

- Do not allow the prongs of the Appliance Plug to become soiled with dust or come into contact with any metal objects.

It automatically starts the boiling process while performing the Steam-Reduce function.

The BOIL light turns on and the Display shows the water temperature in 5-degree increments.

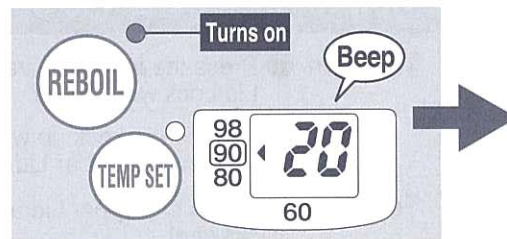

STEAM-REDUCE FUNCTION (activates when boiling):

This feature automatically lowers the power just before boiling to reduce the amount of steam emitting from the Steam Vent. (Water temperature will be about 100°C when boiling.)

- Steam may become more noticeable during winter when the room temperature is colder or the amount of water is lower.

When boiling has completed, a melody sounds and it automatically switches to 90°C Keep Warm mode.

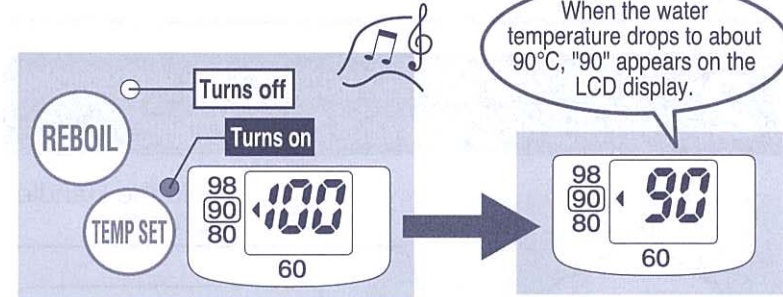

Time required to boil water:

- 2.2L **Approx. 26 minutes** ^{※1}
- 3.0L **Approx. 33 minutes** ^{※1}
- 4.0L **Approx. 42 minutes** ^{※1}

^{※1} Includes approx. 4 minutes to Dechlorinate.

(At a room temperature of 20°C with the Inner Container filled to the Maximum Water Level Line with water temperature at 20°C.)

90°C KEEP WARM MODE:

You can reduce electricity consumption^{※2} by about 25% for 2.2L size, 27% for 3.0L size and 28% for 4.0L size during 90°C Keep Warm mode compared with 98°C Keep Warm mode.

^{※2} The energy savings has been calculated under the conditions of using the product 24 hours a day, 365 days a year, refilling water twice a day, reboiling twice a day, then deducting the electricity for boiling & reboiling twice per day.

- At your initial use or when using the product after a long period of storage:

Attach the Filter, fill the Inner Container with water to the MAX line and boil as directed. Once it reaches a boil, dispense about 1 liter of water and dispose the remaining water. Fill with fresh water.

- When using mineral or Alkalized ionic water:

When mineral or Alkalized ionic water is used, a floating residue may develop or a milky white substance may form on the surface of the Inner Container. This is due to the ingredients in the water and is harmless to your health. Frequent cleaning is recommended.

The first time you use the product you may notice the smell of plastic. This is normal and will gradually fade away.

How to change the Information Sound from Melody to Beep. (see p.12)

How to set the Keep Warm mode:

- 98°C Keep Warm mode. (see p.10)
- 80°C Keep Warm mode. (see p.10)
- 60°C Keep Warm mode. (see p.11)

NOTE

- Add water when the water level is low during the Keep Warm mode. (The product automatically begins heating the water.) If the water level is still not high enough, it will not automatically switch to Boil. In this case, press the REBOIL button to manually start the process. (see p.9)
- Please follow the instructions below to reduce the risk of scalding:
 - Do not cover the Steam Vent with a cloth.
 - Be careful of steam coming out from the Steam Vent.
 - Do not open the Upper Lid while the BOIL light is on.
 - Do not dispense hot water while it is boiling.

DISPENSE HOT WATER

1 Press the **UNLOCK** button.

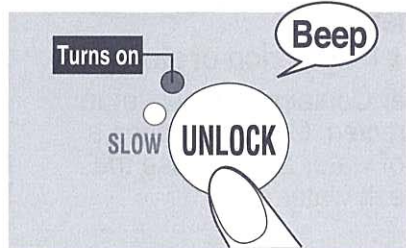

The **UNLOCK** light turns on and hot water can be dispensed.

- When the **UNLOCK** light is off, water cannot be dispensed.

NOTE

- Do not unlock and press the **DISPENSE** button if the Inner Container is empty.

2 Press the **DISPENSE** button to dispense hot water.



Do not swivel the product while dispensing water.

- Initially upon boiling or if it has been a while after dispensing, the water may not be very hot. Please discard the first cup (of the hot water).
- Do not attempt to dispense hot water while boiling.
- Water may not dispense smoothly immediately after boiling.
- Be careful as the Body heats up during the Boil and Keep Warm modes.

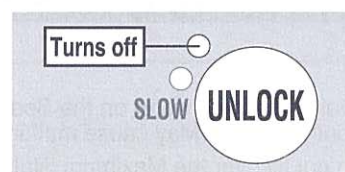

10 seconds after dispensing, the UNLOCK light turns off and the Automatic Dispense Lock is activated.

Automatic Dispense Lock

A safety function to prevent hot water from dispensing if the **DISPENSE** button is accidentally pressed.

- Even if no water is dispensed, the Automatic Dispense Lock will be activated after about 10 seconds.

Do not tilt or shake the product after dispensing. Hot water may drip from the Spout, causing scalds.

DISPOSE WATER

1 Unplug the Power Cord and detach the Upper Lid.

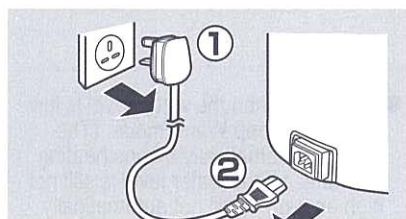

2 Hold the product with both hands and dispose water where indicated "EMPTY FROM HERE" on the wall of the Inner Container.

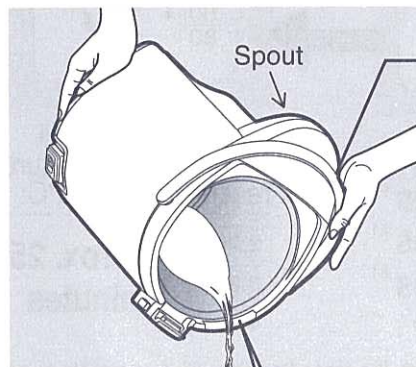

Water Removal Area
EMPTY FROM HERE

Hold the Handle securely.

When disposing hot water:

- Take precaution with the hot water and steam. You may scald yourself.
- Take precaution as hot water may drip from the Spout, causing scalds.

Automatic Shut-Off function

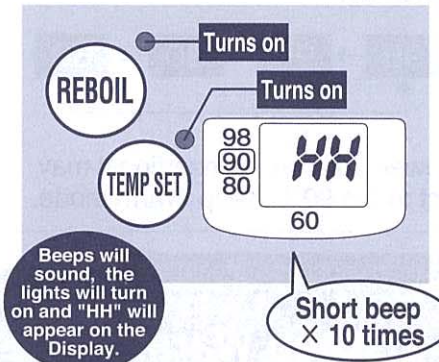

The Automatic Shut-Off function activates to shut down power to the heater in order to prevent damage from overheating. The Display will show "HH" to alert you that the Automatic Shut-Off has been activated. The following conditions may cause activation:

- When plugged in without filling the Inner Container with water.
- When the water level is lower than the REFILL Line and boiling has been attempted.
- When the Inner Container is empty or the Upper Lid is left open for adding water.
- When pouring in hot water immediately after plugging in the unit.

- Be careful not to repeat the boiling process without filling the Inner Container with water, as the Nonstick Coating may discolor and peel.

Remedy

Unplug the product. Allow the Inner Container to cool. Fill the Inner Container with water and plug back in.

This function is used when reboiling water in the Keep Warm mode.

Reboil mode

Press the **REBOIL** button.

The **BOIL** light turns on when the boiling process begins.

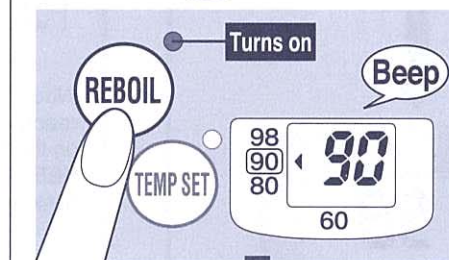

Time required to finish reboiling

(At a room temperature of 20°C with the Inner Container filled to the Maximum Water Level Line.)

98°C Keep Warm mode
Approx. 3~4 minutes
90°C Keep Warm mode
Approx. 5~8 minutes

When the Reboil process is completed, the product switches to Keep Warm mode.

- The Steam-Reduce function may not activate when reboiling.
- Do not attempt to dispense hot water while reboiling.
- Water may not dispense smoothly for a short period of time after reboiling.

NOTE

- Make sure the water level is above the REFILL Line before pressing the **REBOIL** button.

NOTE

- Do not plug or unplug the Power Plug or Appliance Plug with wet hands. (Doing so may cause electric shock or injury.)
- Do not dispose hot water with the Upper Lid in place. (The Upper Lid may come off, spilling hot water and causing scalds.)
- Do not allow water to splash on the Control Panel, Hinge, Handle or Receptacle. (Could cause scalding or breakdown.)
- Please do not lose the Filter while disposing water.
- Dispose the water at least once a day. (Leaving water in the Inner Container can accumulate scale.)

98°C KEEP WARM MODE / 80°C KEEP WARM

Press the **TEMP SET** button to change the settings.

Each press of the button changes the position of the "◀" on the display.



Detaching the Power Cord and reinserting it may return the product to the 90°C Keep Warm mode.

MODE / 60°C KEEP WARM MODE

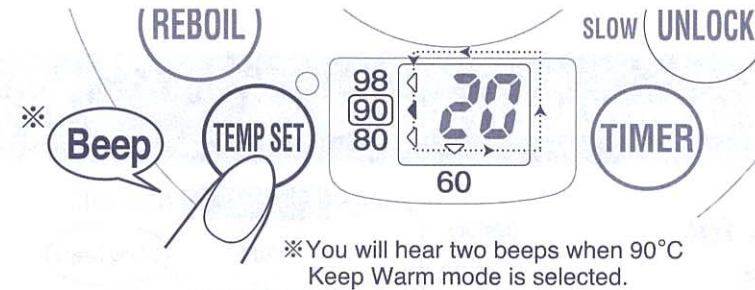

You can change the temperature setting during Keep Warm mode.

(It may start reboiling depending on the water temperature and the selected setting.)

For making coffee, tea and instant noodles

98°C Keep Warm mode

98°C is ideal for making coffee, tea or instant noodles.

Select the "98" on the display.

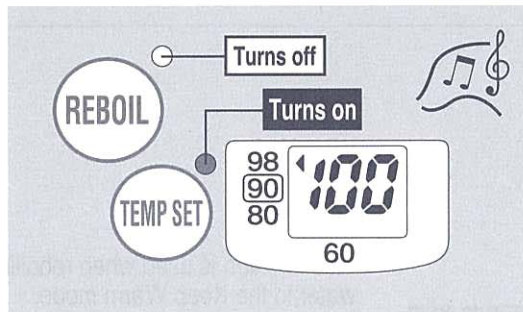

When the boiling process has completed, a melody sounds, the BOIL light turns off, and the KEEP WARM light turns on.

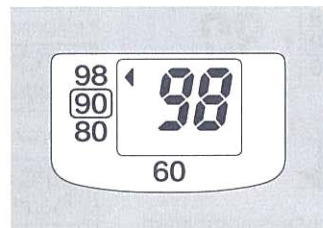

When the water temperature reaches 98°C, "98" appears on the Display.

Depending on the altitude where the product is used, the Keep Warm mode may be set at 96°C-97°C, in order to prevent continuous boiling.

For making Japanese (green) tea

80°C Keep Warm mode

80°C is ideal for making Japanese (green) tea.

Select the "80" on the display.

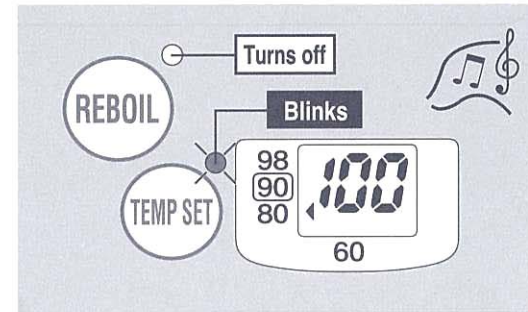

When the boiling process has completed, a melody sounds, the BOIL light turns off, and the KEEP WARM light begins to blink. (If initiated during Keep Warm mode, the light will begin blinking after 2 seconds.)

When the water temperature reaches 80°C, "80" appears on the Display, and the KEEP WARM light stops blinking and remains on.

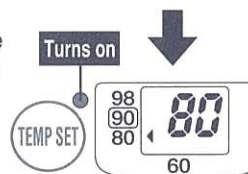

- The length of time for the water temperature to reach 80°C will vary depending on the amount of water and room temperature.
- If you wish to shorten the time, add less water to the Inner Container.
- If water is added as the temperature is lowering during this mode, the product may not automatically reboil.

60°C Keep Warm mode

This will keep the water temperature at about 60°C.

Select the "60" on the display.

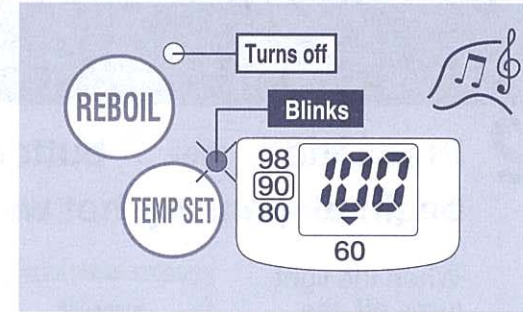

When the boiling process has completed, a melody sounds, the BOIL light turns off, and the KEEP WARM light begins to blink. (If initiated during Keep Warm mode, the light will begin blinking after 2 seconds.)

When the water temperature reaches 60°C, "60" appears on the Display, and the KEEP WARM light stops blinking and remains on.

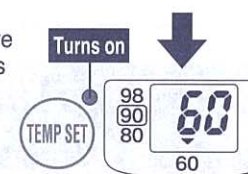

- The length of time for the water temperature to reach 60°C will vary depending on the amount of water and room temperature.
- If you wish to shorten the time, add less water to the Inner Container.
- If water is added as the temperature is lowering during this mode, the product may not automatically reboil.

If the Power Cord is detached:

- Reinsert the Power Cord if it is accidentally detached.
- If the cord is detached for more than a few minutes and reinserted, the product returns to the 90°C Keep Warm mode and may start reboiling automatically.

Length of time for the water temperature to reach 80°C or 60°C after boiling:

(At a room temperature of 20°C with the Inner Container filled to the Maximum Water Level Line.)

80°C Keep Warm mode:

(Length of time for the water temperature to reach 80°C after boiling.)

2.2L	Approx. 1 hour and 10 minutes
3.0L	
4.0L	

60°C Keep Warm mode:

(Length of time for the water temperature to reach 60°C after boiling.)

2.2L	Approx. 4 hours
3.0L	
4.0L	

HOW TO CHANGE THE INFORMATION SOUND / CAFÉ DRIP

How to Change the Information Sound

1 Press the **UNLOCK** button for more than 3 seconds during the boiling process or Keep Warm mode.

● Each button press changes the Information Sound.

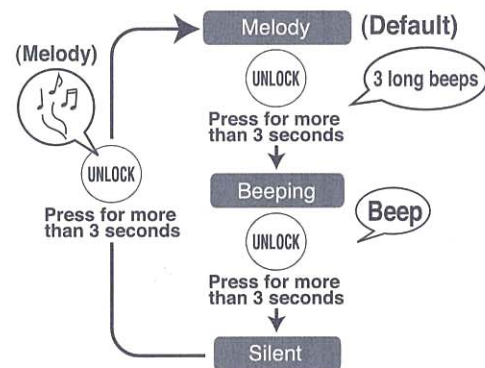

Café Drip Dispensing Mode

1 Press the **UNLOCK** button twice.

When the CAFÉ DRIP light turns on, Café Drip Dispensing mode is activated.

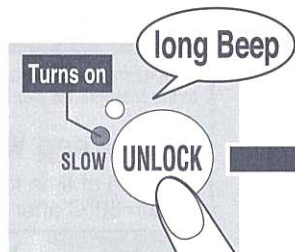

2 Press the **DISPENSE** button to begin dispensing hot water.

When the light turns off, the Automatic Dispense Lock will be activated.

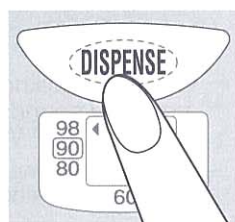

Energy-Saving Timer Function

Press the **TIMER** button until the desired length of time is displayed.

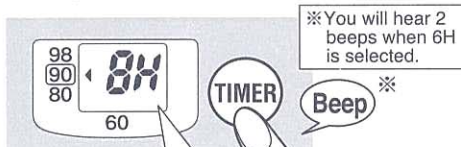

Timer settings: (H for hours)
6H → 7H → 8H → 9H → 10H → Cancel

A melody sounds and the Energy-Saving Timer function is activated.

The Boiling function will complete at the set time.

A melody sounds, the BOIL light turns off and the KEEP WARM light turns on.

Boiling may stop earlier than set, depending on room temperature, water temperature and amount of water.

DISPENSING MODE / ENERGY-SAVING TIMER FUNCTION

● **Information Sound:** The product informs you with a melody or beeps that it has finished boiling or the timer has been set.

2 Once your desired sound (melody or beep) is heard, the setting is completed.

- If the Silent setting is selected, a beep will indicate the setting has completed.
- The Information Sound will return to Melody if the product is unplugged.

When and what types of Information Sounds are heard:

Type	Melody	Beeping	Silent
When			
Timer is set	Beautiful Dreamer	×	×
Boiling stops	Minuet	5 long beeps	×

This mode decreases the amount of water dispensed to 60% of the normal setting, making it suitable for brewing café drip coffee.

- Pressing the UNLOCK button again during Café Drip Dispensing mode returns it to the normal dispensing mode.
- You can use the Café Drip Dispensing mode for about 60 seconds while the CAFÉ DRIP light is on.
- If the water level is low, it may take longer for water to begin dispensing after pressing the DISPENSE button.
- If the water level is low or boiling has just completed, water may not dispense smoothly.

NOTE

- Be careful not to burn yourself.
- If using a cone filter placed directly on a cup, be careful not to let it fall inside the cup while brewing.
- When using a manual drip coffee cone, dispense a cup of hot water before brewing. (The first cup may not be hot enough.)

This function helps save energy by shutting off electricity to the product when not in use, and completes boiling in the selected length of time. The heater is turned off until ready to begin boiling.

SAVINGS!

You could save electricity by about 30% when 98°C Keep Warm mode is selected, and 25% when 90°C Keep Warm mode is selected.

(The energy savings has been calculated under the conditions of using the product 24 hours a day, 365 days a year, refilling and boiling water twice a day, reboiling once a day, and using the Energy-Saving Timer set at 8H.)

NOTE

- If the Power Cord is detached, the Energy-Saving Timer function will be cancelled and must be reset.
- To cancel the Timer, press the TIMER button several times or press the REBOIL button once.

CLEAN AND MAINTENANCE

Always unplug the Power Cord, dispose all water, and allow to cool completely before cleaning.

NOTE

- Do not attempt to dry the product by turning it upside down when the bottom is wet. (Water may get inside the body and cause it to break or rust.)
- Do not use a thinner, benzene, abrasive cleansers or brushes (nylon/metal), bleach or anything that may damage the surface of the product. (May cause damage to the Nonstick Coating.)
- Do not use a dishwasher or dish dryer for cleaning or drying. (May cause the plastic parts to deform.)
- Before storing the product for a longer period of time, dry it completely and pack in a plastic bag to prevent odors from being absorbed.

Inner Lid Wipe with a soft wet sponge.

Inner Container Perform the Citric Acid Cleaning (see p.15) periodically.

Especially when...

- Red rust-like spotting is visible on the Inner Container.
 - Milky white or gray discoloration and/or filmy objects are found in the water.
 - Boiling is louder than usual.
 - Hot water has an odor.
- (The condition of the Inner Container will vary depending on the water quality and frequency of use.)

Filter Remove the Filter from the Inner Container and wash with a soft brush.

Pull the Filter up to release, and press down firmly to attach.

- If you find it difficult to clean the Filter, replace it with a new one.
- Never use the product without installing the Filter. (The Filter prevents foreign objects from entering the Electric Pump and obstructing the flow of hot water.)

Power Cord Wipe clean with a dry cloth.

Body/Upper Lid Wipe clean with a damp well-wrung cloth.

- Do not wash any part of the Body or Control Panel with water. (May cause malfunction or rust.)

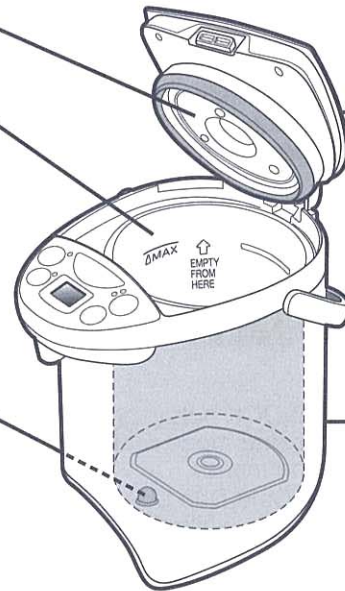

HOW TO REPLACE THE INNER LID GASKET

The Inner Lid Gasket may need to be replaced due to time and wear. Check it about once a year.

Wipe new Inner Lid Gaskets with a wet soft sponge before attaching to the Inner Lid.

To remove the Inner Lid Gasket

- 1 Remove the three screws, and remove the Inner Lid.

- Do not lose these screws.

- 2 Remove the Inner Lid Gasket which is installed on the Inner Lid.

After removing the Inner Lid, check the plastic part of the Upper Lid for abnormalities.
→ If this part is discolored or if it feels rough to the touch, replace it (there will be a charge for this).

To attach the Inner Lid Gasket

- 1 Fit the Inner Lid Gasket securely to the outer circumference as shown in the figure.
- 2 Line up the pin on the Upper Lid with the hole on the Inner Lid correctly with the Upper Lid, and tighten the three screws securely.

Hot water may leak from the gap between the Upper Lid and the Body when tilted if the Inner Lid Gasket becomes old and turns white. This may result in scalds. If hot water spews from the gap or there is steam even after replacing the Inner Lid Gasket, other parts may be in need of repair. Please contact the retail store where you purchased this product.

When the Inner Lid Gasket takes on a white discoloration, please purchase and replace with a new one.

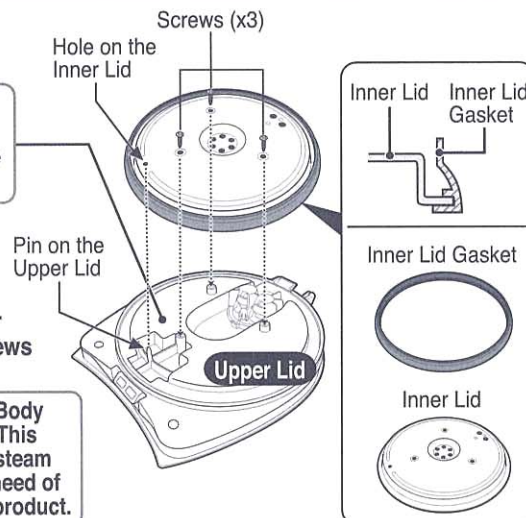

Perform every 1-3 month(s) of usage

HOW TO PERFORM CITRIC ACID CLEANER

Do not drink the water used for citric acid cleaning.

NOTE

In order to prevent gas bubbles and bubbling-over, the Citric Acid Cleaner for Electric Water Boilers (CD-K03E-JU) is recommended for cleaning. To purchase this cleaner, please visit an authorized Zojirushi dealer.

Preparation:

Check that the Filter is attached to the Inner Container.



NOTE

- If the Filter is dirty, remove it from the Inner Container, wash with a soft brush and reinstall.

- 1 Put 1 package of the Citric Acid Cleaner CD-K03E-JU in a cup and add warm water to dissolve. Pour it into the Inner Container and fill with water to the Maximum Water Level Line.

NOTE

- Do not fill over the Maximum Water Level Line. (Hot water may spill out, resulting in scalds.)

- 2 Close the Upper Lid, insert the Power Plug and press the **REBOIL** button for more than 3 seconds.

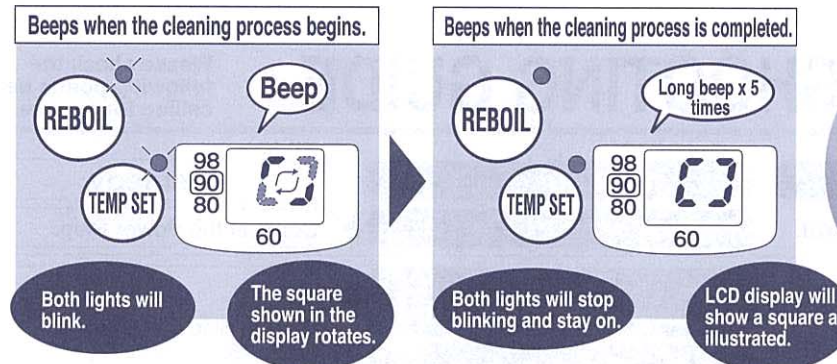

Cleaning time: **Approx. 1.5 hours.**

*Cleaning times may vary depending on the amount of water, water temperature and room temperature.

- 3 Unplug the Power Plug, detach the Upper Lid and dispose water where indicated "EMPTY FROM HERE." (Please take precautions not to splash water on the Hinge.)

NOTE

- Repeated citric acid cleaning may be necessary for hard-to-remove residues or if water does not dispense smoothly.

- 4 To remove the smell of citric acid, fill the Inner Container with water. Boil and dispense about a cup of hot water, allow to cool, then dispose the remaining water.

When disposing hot water:

- Take precaution with the hot water and steam. You may scald yourself.
- Take precaution as hot water may drip from the Spout, causing scalds.

To cancel the Citric Acid Cleaning at any time, unplug the Power Plug for more than 5 seconds.

REPLACEMENT PARTS

- Replacement parts may be available for an additional charge. Please replace damaged parts only with new parts.
- When replacing parts, please record the model number and part name beforehand. Then contact the store where you purchased the product.



Parts Names	Parts Number
Inner Lid Gasket	62-5702
Filter	62-7402
Citric Acid Cleaner for Electric Water Boilers (30 g X 4 packets)	CD-K03E-JU



Q&A ON PRODUCT USE

Is it okay to use the product for heating liquids other than water?	Do not fill the product with any liquid other than water. It may cause malfunction, or may overflow and cause scalding.	P.2 P.3
Does the water need to be changed every day?	To prevent scale from building up, please change the water at least once a day.	P.8
Is it okay to use mineral water?	Yes. However, when mineral water is used, a floating residue may develop or milky white substance may form on the surface of the Inner Container. This is due to the ingredients in the water and is harmless to your health.	P.7
Is it okay to use Alkalized Ionic Water?	Yes. However, calcium tends to build up on the surface of the Inner Container with this type of water, so frequent cleaning is recommended.	P.15
I accidentally drank water while performing the Citric Acid Cleaning. Is this harmful to my health?	Please follow the instructions shown on the package of the citric acid cleaner CD-K03E-JU.	
Is it okay to go out while the product is switched on?	It is safe to use the product unattended as it has an Automatic Shut-Off function (power to the heater will be automatically turned off), which will be activated once it is empty of water.	P.9

TROUBLESHOOTING GUIDE

Please check the following points before calling for service.

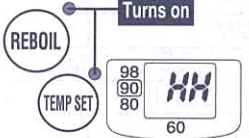
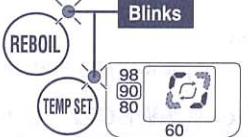
	Condition	Cause	Remedy
Boil mode	Water does not boil.	Power Plug is not connected to an electrical outlet.	Connect the Power Plug.
	Hot water has a disagreeable odor.	Scale or other residue has accumulated on the Inner Container.	Perform citric acid cleaning. (see p.15)
		You have not performed citric acid cleaning regularly.	
		The product has not been used for a long time.	Boil water, unlock and dispense about 1 liter of hot water. Discard the remaining. (see p.7)
	<ul style="list-style-type: none"> ●A mild plastic odor may be noticeable with a new product. This odor will gradually fade away. ●You may smell chlorine (used for sterilization of tap water) after boiling. 		
	Water pours out by itself from the Spout or Steam Vent.	Check that the Inner Container is not filled over the Maximum Water Level Line.	Pour out the excess water until it is below the Maximum Water Level Line.
Dispense hot water	Water is not hot.	<ul style="list-style-type: none"> ●Initially upon boiling or if it has been a while after dispensing, the water may not be very hot. Please discard the first cup (of the hot water). 	
	Water does not dispense or does not pour properly.	Hot water does not pour properly a few minutes after boiling.	Open the Upper Lid to release air bubbles, then close. (Be careful of steam when opening the Upper Lid.)
		Scale or other residue has accumulated on the Inner Container and Filter.	Clean the Inner Container and Filter. (see p.14)
		The Automatic Dispense Lock is engaged.	Press the  button, then press the  button. (see p.8)
		Power Plug is not connected to an electrical outlet.	Connect the Power Plug.
		Calcium may build up in the water route and prevent water from dispensing smoothly.	Perform citric acid cleaning. (see p.15)

	Condition	Cause	Remedy
Keep Warm	A filmy, floating residue is noticeable. (Could the Nonstick Coating be peeling off?)	Residue is due to the mineral content in water, not from corrosion of the Inner Container or peeling of the Nonstick Coating.	Perform citric acid cleaning. (see p.15)
	Milky white and rough-surfaced objects have built up on the surface of the Inner Container. (Boiling is louder than usual.)	Excessive accumulation of scale and other build-up on the surface of the Inner Container can cause boiling to become louder.	<div style="border: 1px solid black; padding: 5px;"> <p align="center">Scale</p> <p>Over time and use, calcium and other minerals contained in water build up on the surface of the Inner Container and the Filter. It is called "scale" and is harmless to your health.</p> </div>
	Red rust-like spotting appears on the Inner Container surface.	Caused by iron in the water, not deterioration of the Inner Container.	
	White floating residue is noticeable.	Removing the Inner Lid, check the plastic part of the Upper Lid for abnormalities.	If this part is discolored or if it feels rough to the touch, replace it. (see p.14)
	Water is not hot.	Is the Timer set?	Press the  button. (see p.9)
Error Displays and their meaning	A beep sounds, lights turn on and "HH" appears on the Display.	 <p>Turns on</p>	The Inner Container is low on water or hot water was added to the Inner Container, causing the Automatic Shut-Off function to engage. (see p.9)
	2 lights blink at the same time and the Display shows a rotating square.	 <p>Blinks</p>	The Inner Container is in a citric acid cleaning cycle. (see p.15)
	 is displayed.	Indicates malfunction.	Please contact the store where you purchased the product.
Replacement for the Upper Lid	Inner Lid Gasket	<ul style="list-style-type: none"> ●The Inner Lid Gasket is replaceable so please check it every year. When steam comes out from the gap between the Upper Lid and the Main Body, or becomes white or discolored, replace it with a new one. (see p.14) 	
	Plastic Parts	<ul style="list-style-type: none"> ●The plastic part of the Upper Lid may deteriorate over use. When replacing the Inner Lid Gasket, check the plastic part. If discoloration occurs or the surface becomes coarse, replace the Upper Lid (must purchase separately). (We take care in only using materials for the plastic parts that are safe and hygienic for food contact.) 	
Miscellaneous	The Body becomes hot.	<ul style="list-style-type: none"> ●When the water temperature and/or room temperature is high, the outer surface of the Body may reach up to 60°C. This is not a malfunction. 	
	The Power Cord becomes hot.	<ul style="list-style-type: none"> ●The Power Cord may become hot while the water is boiling. This is not a malfunction. 	
	You hear a light sound when opening and closing the Upper Lid.	<ul style="list-style-type: none"> ●This sound is normal and comes from the movement of the weight which prevents hot water from overflowing when the product is closed. 	
	Humidity builds in the Display window.	<ul style="list-style-type: none"> ●If water is filled from a faucet or the product is placed directly on a sink and the bottom becomes wet, water may go inside of the Main Body and the Display may show moisture. If this happens, stop using the product and allow it to dry as it may cause short circuit or electric shock. 	
<div style="background-color: #333; color: white; padding: 5px; text-align: center;"> <p>The Nonstick Coating of the Inner Container may become damaged over use. Contact the retail store where you purchased this product.</p> </div>			

SPECIFICATIONS

Model No.	CD-WBQ22	CD-WBQ30	CD-WBQ40	
Capacity	2.2 liters	3.0 liters	4.0 liters	
Rating	AC 220–230V 50/60Hz			
Electric Consumption	640–700W			
Average Power Consumption during Keep Warm	98°C	Approx. 38W	Approx. 45W	Approx. 51W
	90°C	Approx. 33W	Approx. 38W	Approx. 44W
	80°C	Approx. 26W	Approx. 31W	Approx. 36W
	60°C	Approx. 15W	Approx. 18W	Approx. 21W
Length of the Power Cord	0.75m			
External Dimensions (cm)	21 (W) x 28.5 (D) x 25 (H)	21 (W) x 28.5 (D) x 29 (H)	21 (W) x 28.5 (D) x 34 (H)	
Weight (including the Power Cord Set)	Approx. 2.1kg	Approx. 2.3kg	Approx. 2.5kg	

Model No.	CD-WBH30C	CD-WBH40C	
Capacity	3.0 liters	4.0 liters	
Rating	AC 220V 50Hz		
Electric Consumption	640W		
Average Power Consumption during Keep Warm	98°C	Approx. 45W	Approx. 51W
	90°C	Approx. 38W	Approx. 44W
	80°C	Approx. 31W	Approx. 36W
	60°C	Approx. 18W	Approx. 21W
Length of the Power Cord	1.8m		
External Dimensions (cm)	21 (W) x 28.5 (D) x 29 (H)	21 (W) x 28.5 (D) x 34 (H)	
Weight (including the Power Cord Set)	Approx. 2.4kg	Approx. 2.5kg	

- The average Keep Warm electric power consumption is for one hour, provided that the Inner Container is full and the room temperature is approximately 20°C.
- The height refers to the product when the handle is down.
- In high altitudes or severely cold areas, the product may not perform as specified. Avoid using the product in such areas or in other extreme conditions.

<for CD-WBQ22 · CD-WBQ30 · CD-WBQ40 only>

WARNING - THIS APPLIANCE MUST BE EARTHED

IMPORTANT

The wires in this mains lead are coloured in accordance with the following code:

Green-and-yellow:Earth Brown:Live Blue:Neutral

If the colours of the wires in the mains lead of this appliance do not correspond with the coloured markings identifying the terminals in your plug, proceed as follows.

The wire which is coloured green-and-yellow must be connected to the terminal in the plug which is marked with the letter E or by the earth symbol or coloured green or green-and-yellow. The wire which is coloured blue must be connected to the terminal which is marked with the letter N or coloured BLACK.

The wire which is coloured brown must be connected to the terminal which is marked with the letter L or coloured RED.

This appliance must be protected by a 13A fuse if a 13A (BS1363) plug is used or, if any other type of plug is used, by a 10A fuse either in the plug or adaptor or at the distribution board.

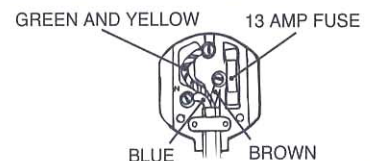

How to change the Fuse

If the Power Plug of your Power Cord (See P.4) is,

- A type that can be disassembled. Refer to above.
- A solid molded type that can not be disassembled. Please refer to the following.
 1. Open the Fuse Cover of the Power Plug.
 2. Replace the Fuse (13A) that is inside with a new Fuse. (Be sure to replace with a 13A Fuse)
 3. Fit back the Fuse Cover with the new Fuse to the Power Plug.

Caution Do not connect the Fuse directly to the Power Plug. The Fuse Cover can not be attached.

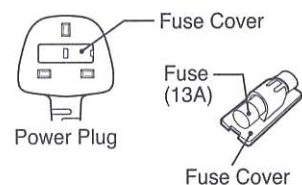



微电脑电动给水热水瓶 使用说明书

CD-WBH30C/CD-WBH40C CD-WBQ22/CD-WBQ30/CD-WBQ40

- 感谢您购买本产品。
- 请在使用前仔细阅读使用说明书，以便正确使用。并请阅读后妥善保管。

目录

使用前

- 安全注意事项 2
- 各部位名称和使用方法 4

使用方法

- 烧水 6
- 注水 8
- 倒掉剩余热水时 8
- 防止空烧 9
- 再沸腾 9

便利的功能

- 98℃保温 / 80℃保温 10
- 60℃保温 11
- 报知音的切换方法 12
- 滴落式冲泡咖啡 12
- 节电定时 12

清洗和保养

- 清理 14
 - 更换内盖垫圈 14
- 柠檬酸清洗方法 15
- 更换零件 15

困惑时

- 商品Q&A 16
- 认为发生故障时 16
- 规格 18

ZOJIRUSHI CORPORATION
OSAKA, JAPAN



安全注意事项 请务必遵守。

- 为防止给您或他人带来危害或损害，请遵守以下注意事项。
- 每项均为涉及安全的重要内容，请务必遵守。

警告 表示如果操作有误，可能会造成死亡或重伤*1的内容。

注意 △符号表示有警告及需注意的内容。具体内容在图中或在附近以文字或图表示。

注意 表示如果操作有误，可能会造成人身伤害*2或财产损失*3的内容。

禁止 ⊘符号表示禁止事项。具体内容在图中或在附近以文字说明或图表示。

*1 这里的重伤指的是由于失明、外伤、烧伤（高温、低温）、触电、骨折、中毒等，留有后遗症及需住院或长期去医院治疗的情况。

指示 ●符号表示强制或指示事项的内容。具体内容在图中或在附近以文字说明或图表示。

*2 人身伤害指的是无需住院或长期去医院治疗的外伤、烧伤或触电事故。

*3 财产损失指的是波及到房屋、家庭财产、家畜、宠物等的扩大损害。

警告

<p>⊘ 请勿使用交流电220V (CD-WBH30C/40C), 220-230V (CD-WBQ22/ WBQ30/ WBQ40) 以外的电源。否则，会导致火灾、触电。</p>	<p>⊘ 加水时请勿超过最大水量标示。否则，可能会导致热水溢出，造成烫伤。</p> 	<p>⊘ 请勿用力关闭上盖。否则，可能引起热水溢出，导致烫伤。</p>
<p>⊘ 请勿改造。除修理技术人员外不得拆卸修理。否则，有造成火灾、触电、受伤的危险。需修理时，请咨询本公司指定的服务中心。</p>	<p>⊘ 请勿未取下上盖就直接倒剩余的热水。否则，上盖脱落时会溅出热水而导致烫伤。</p>	<p>⊘ 电源线或电源插头有损伤或电源插座松动时请勿使用。否则，会导致触电、短路、起火。</p> 
<p>⊘ 请勿浸水或溅水。请勿放在洗碗池等潮湿的地方。否则，有可能会发生输电不良等故障，以及短路、触电。</p>	<p>⊘ 挪动或倒水时，请勿抱着本体或使其倾斜、晃动或手持上盖。自动锁定状态下如倾斜、倒置本体，可能造成热水从出水口及蒸汽口流出，会导致烫伤。</p>	<p>⊘ 电源线不得受损。请勿过度弯曲、拉伸、扭转、打结、或接近高温处、被重物压迫、挤压、加工等，会造成电源线受损，导致火灾、触电。</p>
<p>⊘ 请勿用湿的手插拔电源插头。否则，可能导致触电或受伤。</p>	<p>⊘ 请勿翻转电热水瓶。即便自动锁定状态下，如倾斜、倒置本体，也可能造成热水从出水口及蒸汽口流出，会导致烫伤。</p>	<p>⊘ 请勿放入或加热除水以外的其他东西。否则会产生气泡、或因该东西溢出而导致烫伤，还会造成出水管堵塞，内容器被烧焦或被腐蚀，防粘涂层脱落。 · 牛奶、酒、汤、备长炭、茶包、茶叶 · 烹煮方便食品 · 软罐头食品的加热或将食材放入塑料袋中加热烹调等</p>
<p>⊘ 请勿将手和脸接触或靠近蒸汽口。否则，会导致烫伤。尤其应注意避免婴幼儿触摸。</p>	<p>⊘ 请勿放入冰块，不得作为保冷使用。否则，可能产生结露现象，造成触电、故障。</p>	<p>⊘ 器具用电源插头不得附着别针等金属物或灰尘。否则，会导致触电、短路、起火。</p>
<p>⊘ 请勿使用抹布等遮挡蒸汽口。否则，热水溢出，可能会导致烫伤。同时可能会造成上盖的变形、变色及故障。</p>	<p>⊘ 请勿将器具用电源插头放入口中。否则，会导致触电、受伤。尤其应注意不要让婴幼儿接触。</p>	<p>⚠ 请务必将电源插头完全插入电源插座。否则，会引起触电、短路、冒烟或起火。</p>

<p>⚠ 需独立使用额定10A以上的电源插座。若与其他器具共用，则多用插座部位会因异常发热导致着火。</p>	<p>⚠ 请盖紧上盖。否则，翻倒时热水流出可能导致烫伤。</p>	<p>⚠ 发生异常、故障时，请立即停止使用。 如照常使用则可能导致冒烟、起火、触电、受伤。 <异常情况、故障示例> · 电源插头、电源线异常发热 · 电源线损伤、接触引起断续通电 · 本体变形或异常过热 · 本体冒烟，有焦糊味 · 本体部分破损，松动或晃动 · 蒸汽喷气持续10分钟以上，无法转换为保温状态 发生上述情况时，请立即拔掉电源插头，必须委托经销商进行检查、修理。</p>
<p>⚠ 电源插头的插脚（插头前端）及插脚的插入面附着灰尘时应仔细擦拭。否则，会引起火灾。</p>	<p>⚠ 在没有安全责任人对本机器的使用给予指挥管理或指示的情况下，运动能力、感觉能力或是智力低下及缺乏经验和知识的人（包括儿童）严禁使用本机器。家长应照看管理好孩子，避免儿童用本机器玩耍。</p>	

注意

<p>⊘ 打开上盖时，请勿接触冒出的水蒸汽。否则，会导致烫伤。</p>	<p>⊘ 请勿靠近墙壁或家具使用。否则，蒸汽或热度会损害墙壁和家具，引起变色变形。</p>	<p>⚠ 不使用时，请将电源插头拔出插座。否则，会导致受伤、烫伤，或因绝缘性恶化而触电、漏电引起火灾。</p>
<p>⊘ 使用过程中或使用完毕后请暂时不要接触高温部位。否则，会导致烫伤。</p>	<p>⊘ 水正在烧开时，请勿倒出热水。否则，可能热水溅出导致烫伤。</p>	<p>⚠ 请在本体冷却后进行清洗。否则，碰到高温部位可能会导致烫伤。</p>
<p>⊘ 搬运本体时，请勿触碰上盖开闭钮。否则，上盖打开会导致受伤或烫伤。</p>	<p>⊘ 必须使用专用电源线。该专用电源线请勿用于其他电器。请勿用于国外型号的电器产品。否则，可能引起故障或起火。</p>	<p>⚠ 拔掉电源插头时，必须手持插头，请勿拉扯电源线。否则，会因触电、短路而起火。</p>
<p>⊘ 请勿在出热水时转动本体。否则，可能热水溅出导致烫伤。</p>	<p>⚠ 内盖垫圈变白时请更换。否则，当倾斜或不慎弄翻时，可能会因热水流出而导致烫伤。</p>	<p>⚠ 电源线破损时，请从厂家或其经销商处取得专用电源线或其组合零件进行更换。</p>
<p>⊘ 请勿放在不平整的地方或不耐热的铺垫物上使用。否则，会引起火灾。</p>		

敬请注意

<p>■ 请勿在热源附近或电磁炉上使用。否则，会导致火灾、故障。</p>	<p>■ 请勿空烧。否则，会导致火灾、故障。</p>	<p>■ 请勿将热水溅到操作面板或水量显示板上。否则，会引起故障。</p> 
<p>■ 请避免摔落、碰撞等撞击。否则，会导致故障、破损。</p>	<p>■ 请勿拖拉本体移动。否则，有可能刮伤桌面等。</p>	
<p>■ 放置在厨房用储物柜等上方使用时，注意不要让水蒸汽喷到天花板上。否则，会导致变色或变形。</p>	<p>■ 请勿在蒸汽会喷到其他电器的地方使用。否则，会因蒸汽导致电器着火、故障、变色、变形。</p>	<p>■ 请勿在收音机等附近使用。请在对收音机、电视机、无线电、对讲机等不产生影响的地方使用。否则可能会产生杂音。</p>
<p>■ 在可能结冻的地方长时间切断电源不使用的情况下，请务必将内容器中的水完全倒净。否则，会因冻结而引起故障。</p>	<p>■ 本产品适用于一般家庭以及下列类似用途。 · 可用于商店、办公室或其他工作环境中的员工用厨房。 · 可用于类似居住的房间或者厨房的环境中。 ※但请勿在不特定人数多的情况下长时间使用。</p>	

各部位名称和使用方法

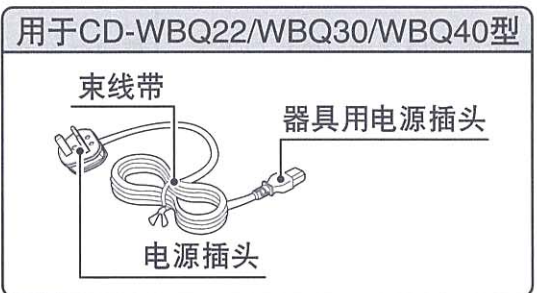
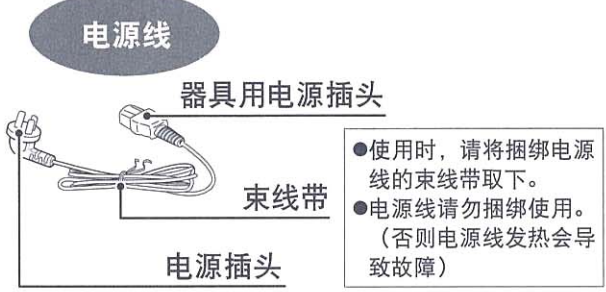
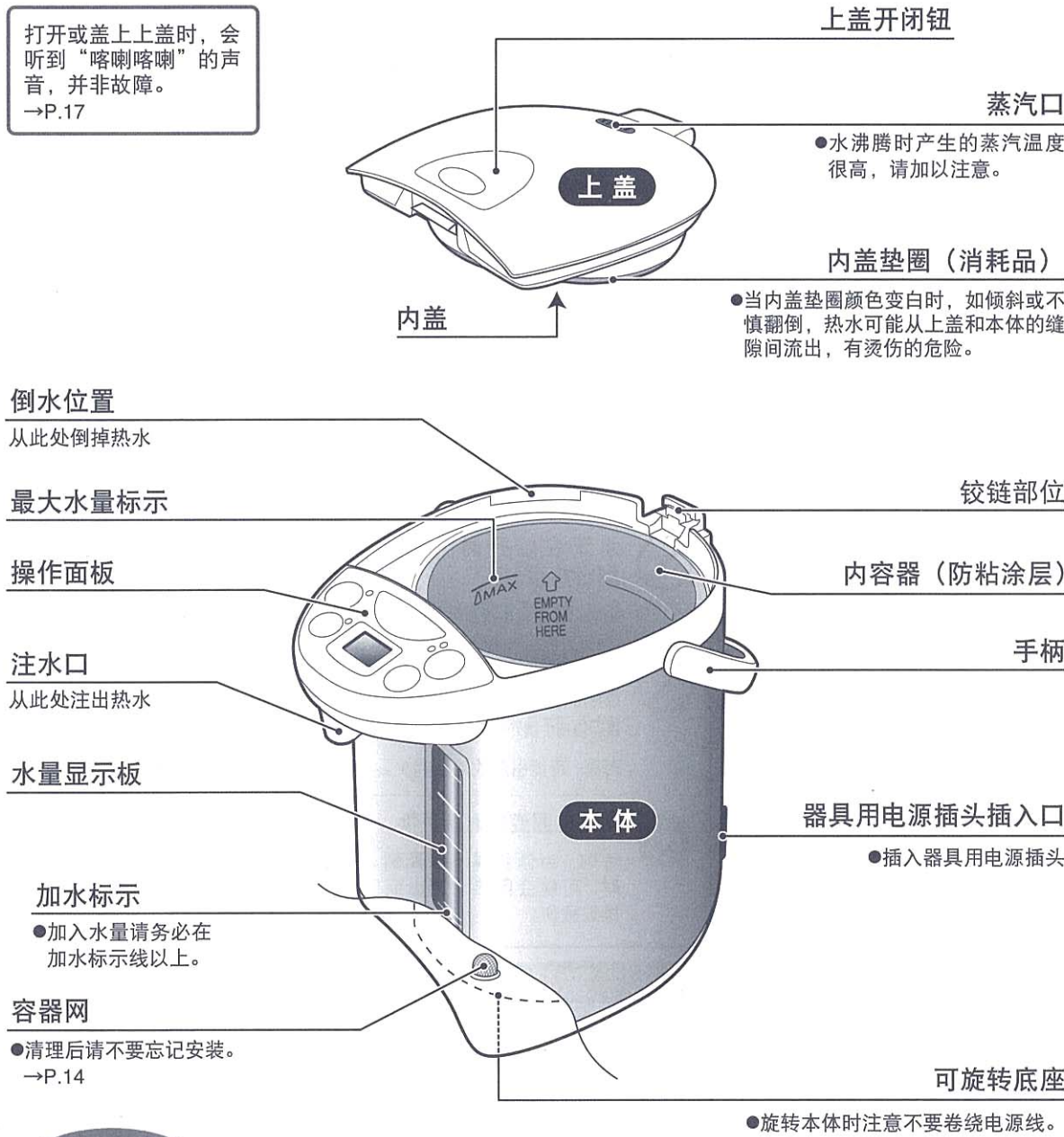

内盖垫圈、容器网属另卖品。破损、遗失的情况下，请向经销店另行购买。

操作面板

●请按下操作键。

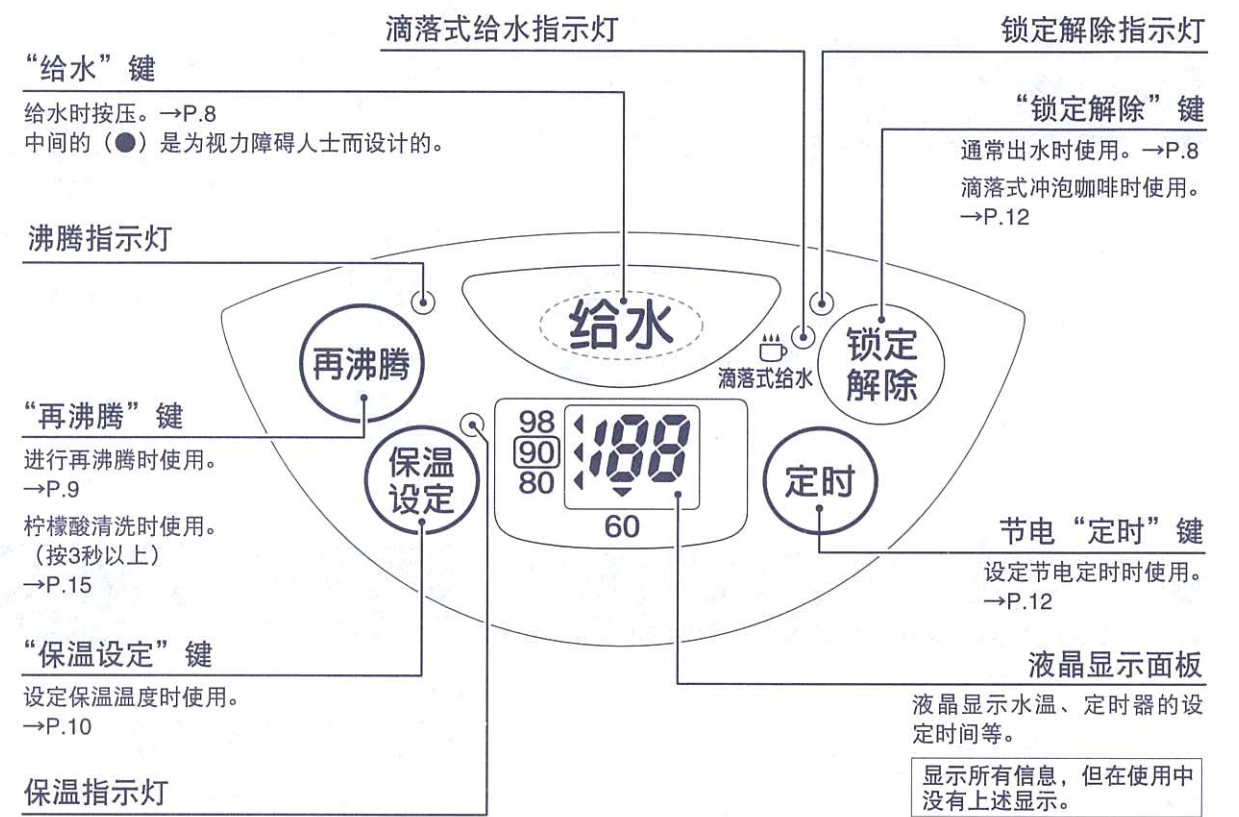

上盖的打开和关闭方法

打开方法

- 1 按“上盖开闭钮”的凹处
- 2 同时勾拉打开上盖

关闭方法 将上盖按下，直至听到“咔嚓”一声上盖关紧为止

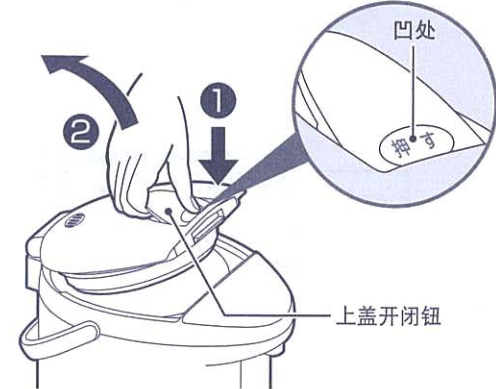

上盖的拆卸和安装方法

拆卸方法

- 1 打开上盖约45度
- 2 按“上盖装卸按钮”
- 3 按住同时向上斜拉出上盖

安装方法 将上盖从斜上方往装卸按钮底部装进即可

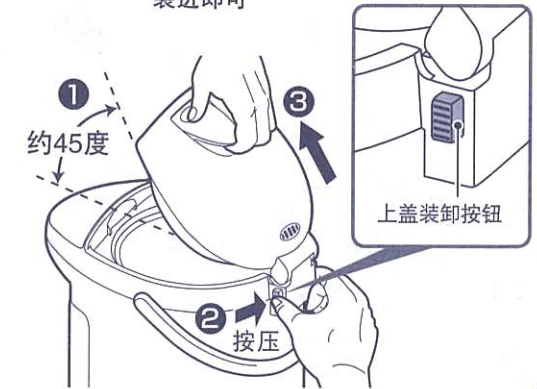

烧水

1 打开上盖，使用其他容器加入水

可根据水位管的条纹粗细，一目了然地知道水量的多少。

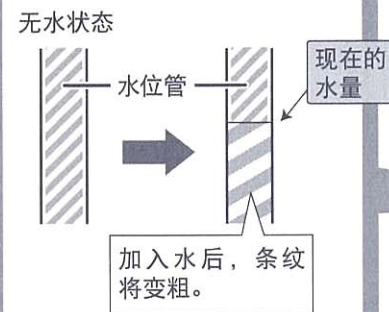

最大水量标示
(△MAX)

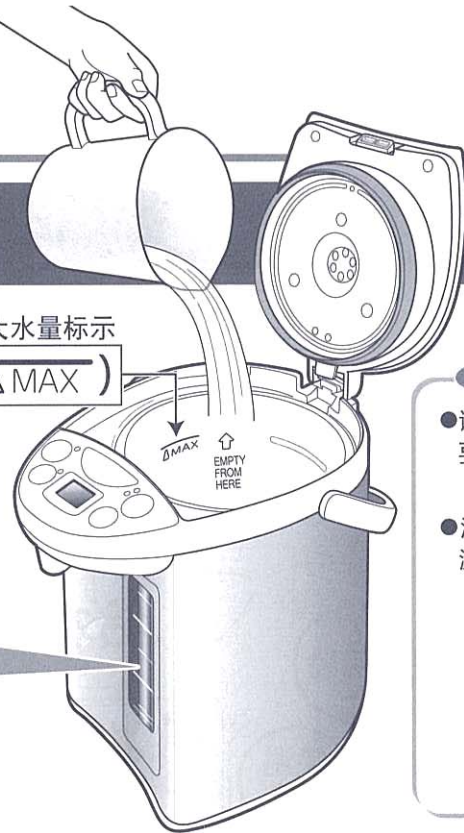

敬请注意

- 请勿直接从水龙头加水，也不要放在洗碗池内将底部弄湿（本体进水会引起故障）
- 注意本体及操作面板上不要溅上水（一旦进水会引起故障）



刚开始使用时，可能会有塑料等异味，随着使用次数的增加会逐渐消失。

●初次使用时

●长时间未使用后

按顺序先加一次水至最大水量标示处，将水烧沸。然后，倒出1L左右的热热水后，倒掉剩余热水后再使用。（请务必安装好容器网。）

●有关矿泉水和碱性离子水的使用

如使用矿泉水和碱性离子水，有时水中会有细小的浮游物、或内容器附着白色粗燥物，这是水质成分（矿物质），并非有害物质。使用矿泉水和碱性离子水时，请勤加清洗。

- 加水时，不得超过最大水量标示（否则会造成热水从蒸汽口溢出）
- 请勿加入热水（否则会启动防干烧功能）→P.9
- 请勿放入除水以外的其他物品
- 请勿放入市场出售的水质改良剂（碳等）及矿物质添加物（否则碎屑会引起堵塞造成故障）

2 关紧上盖，插入电源插头



关紧上盖
(否则，翻倒时可能热水流出导致烫伤)

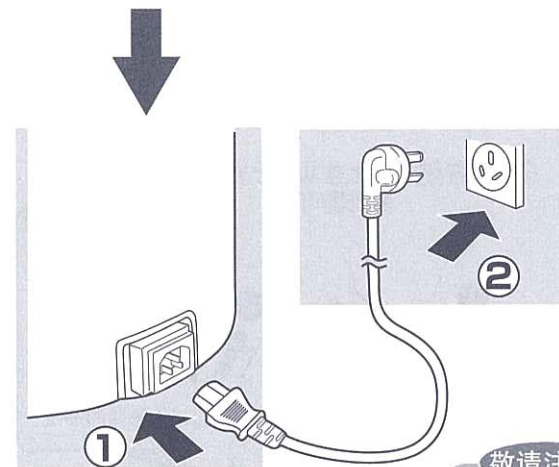

将插头完全插入插座
(否则，会造成触电、短路、冒烟、起火)

进行蒸汽减量

同时自动开始烧水

沸腾指示灯亮时，液晶显示面板显示水温（以5℃为单位）

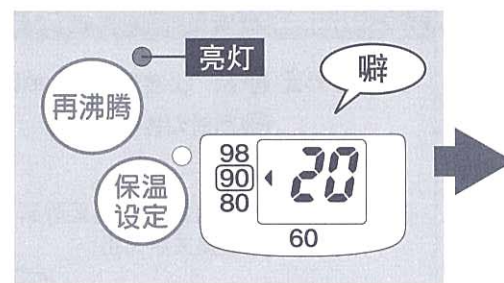

蒸汽减量（沸腾）

接近沸腾时降低加热器的功率，减少蒸汽量进行烧水的功能。

（热水温度约100℃）

- 冬季室温较低或热水量较少时，蒸汽会比较明显。

敬请注意

- 器具用电源插头的插脚不要附着别针等金属物或灰尘等。

烧开后发出乐曲报知音，

并自动开始保温（90℃保温）

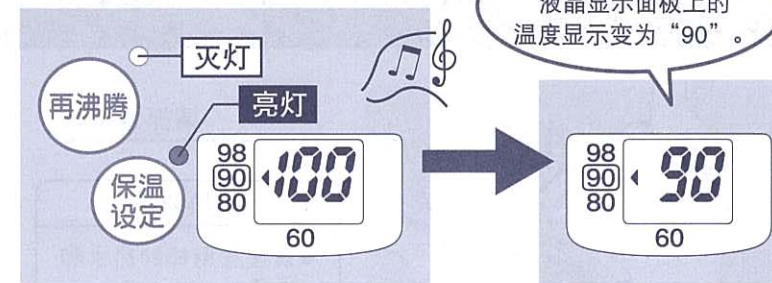

烧开所需时间

3.0L	约33分钟 ^{※1}
4.0L	约42分钟 ^{※1}

（室温20℃，水温20℃，最大水量时）

※1 该时间包括沸腾后去除漂白粉所用的时间（约4分钟）。

90℃保温

与98℃保温相比：

- 型号为30时，可节省约27%的保温用电费^{※2}
- 型号为40时，可节省约28%的保温用电费^{※2}

※2 以每天（24小时）加水二次烧开、再沸腾各二次，一年365天使用为基准。保温时不包括烧水二次、再沸腾二次。

温度达到约90℃后液晶显示面板上的温度显示变为“90”。

到达90℃所需时间

3.0L	} 约25分钟
4.0L	

（室温20℃，最大水量时）

本使用说明书中对如何设置初始乐曲报知音的操作方法进行说明。→P.12

●保温的设定●

- 98℃保温 →P.10
- 80℃保温 →P.10
- 60℃保温 →P.11

敬请注意

- 保温状态下如水量减少请加水。（可自动加热煮沸）
但加入水量较少时，有时无法自动开始加热。此时请按“再沸腾”键。→P.9

- 为避免造成烫伤，请遵守以下事项。

- 请勿将抹布盖在蒸汽口上。
- 小心蒸汽口冒出的蒸汽。
- 沸腾指示灯亮灯时不要打开上盖。
- 在加热过程中不要注水。

注水

1 按 **锁定解除** 键



锁定解除指示灯亮时表示能够注水。

- 锁定解除指示灯灭时无法注水。

敬请注意

- 内容器中没水时，请不要按“锁定解除”键及“给水”键。

2 按 **给水** 键注水

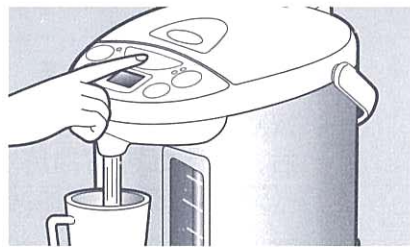

注水时，注意不要转动本体。

- 刚沸腾时或一段时间未注水使用时，水可能不太热。请将第一杯热水倒掉。
- 水正在烧开时，请勿倒出热水。
- 刚沸腾时，暂时可能会出水不畅。
- 沸腾时及保温状态下本体会变热，请小心。

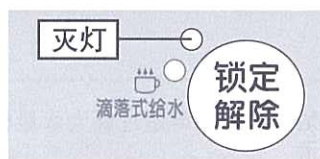

注水结束约10秒后，锁定解除指示灯灭，“给水”键会自动锁定。

自动给水锁定

- 防止热水在“给水”键被误按到的情况下漏出来的安全功能。
- 即使没有注水，约10秒后也会自动锁定。

注水后，请勿倾斜或者摇晃本体。
(注水口的热水滴下，会导致烫伤)

倒掉剩余热水时

1 拔掉电源插头，卸下上盖

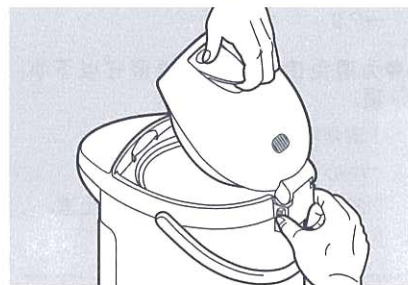
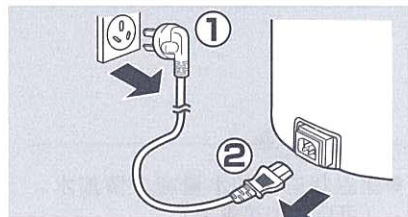

2 用两只手拿着本体，从“倒水位置”把水倒掉

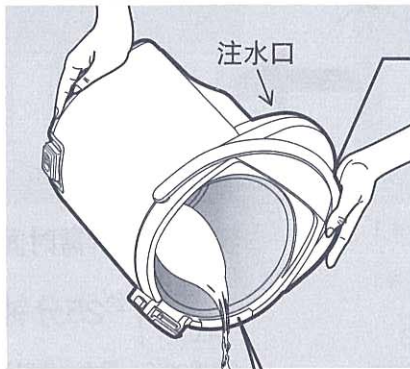

倒水位置
EMPTY FROM HERE

请抓紧手柄

倒热水时

- 请注意倒掉的热水和蒸汽。(否则会导致烫伤)
- 请注意注水口的热水滴。(否则会导致烫伤)

防止空烧

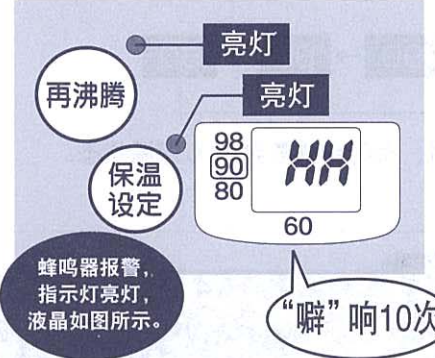

- 反复干烧会造成防粘涂层变色、脱落，故请注意。

下列情况发生时，为防止过热引起故障，将启动防止干烧功能，加热器断电，通过显示和蜂鸣器报警告知。

- 未加水就插入电源插头时
- 水量低于加水标示进行烧水时
- 热水用完后未再加水时或打开上盖却未加水时
- 插上电源插头后立即加入热水时

处理 拔下插头，等内容器充分冷却后加水，然后插上插头。

再沸腾 用于重新烧开保温状态下的热水。

按 **再沸腾** 键 沸腾指示灯亮，开始烧水。

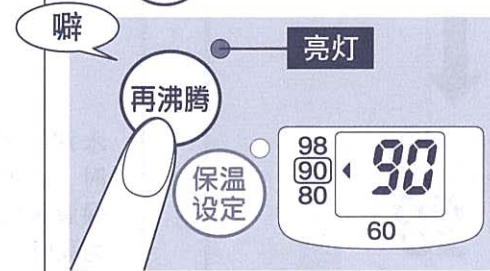

完成再沸腾所需时间
(室温20℃, 最大水量时)

98℃保温时
约3~4分钟
90℃保温时
约5~8分钟

再沸腾结束后自动进入保温状态。

- 再沸腾时，有时不会启动蒸汽减量功能。
- 水正在再沸腾时，请勿倒出热水。
- 再沸腾刚结束时，可能会出现热水流出不畅的情况。

敬请注意

- 进行再沸腾时，请确认水量在加水标示线以上，再按“再沸腾”键。

敬请注意

- 请勿用沾湿的手插拔电源插头或手持器具用电源插头。(否则会导致短路、触电)
- 请务必卸下上盖后再倒掉剩余热水。(上盖脱落会导致烫伤)
- 注意不要让热水淋到操作面板、铰链部位、手柄、电源插头插入口。(否则会导致烫伤或故障)
- 请勿弄丢容器网。
- 建议每天把剩余热水倒掉。(否则易造成水垢附着)

98°C保温 / 80°C保温 / 60°C保温

按 **保温设定** 键更改设定

每按一次键，显示面板中的“◀”标记会移动，请根据用途选择设定。



按下插头再次插入时，有时会恢复到90°C保温状态。

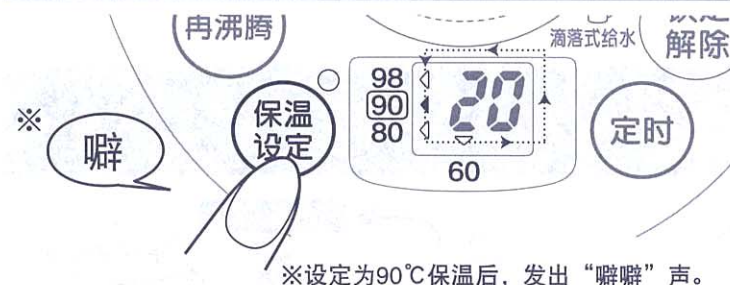

●在保温状态中也能进行切换。
(根据热水温度，有时会自动开始再沸腾。)

冲泡咖啡、红茶、泡面（方便面）时

98°C保温

98°C时适合冲泡咖啡、红茶、泡面（方便面）。

选择“98”

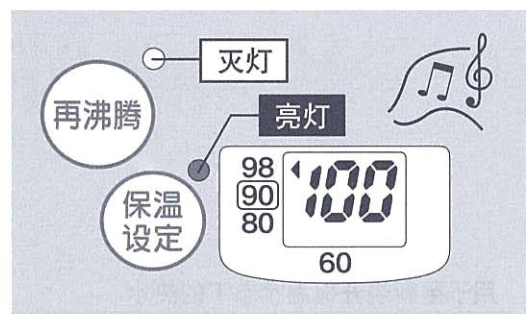

沸腾后响起乐曲报知音，沸腾指示灯灭，保温指示灯亮。

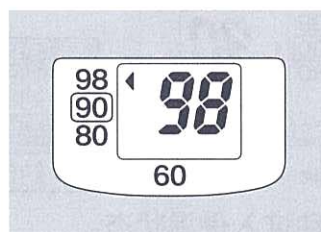

水温降至约为98°C时，温度显示更新。

●为防止继续沸腾，根据气压等条件，温度可保持在96~97°C。

日本茶

80°C保温

80°C为冲泡日本茶（煎茶）的适宜温度。

选择“80”

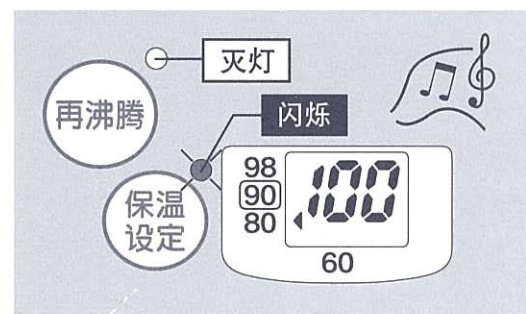

沸腾后响起乐曲报知音，沸腾指示灯灭，保温指示灯闪烁。
(在保温状态下进行设定时，设定80°C保温2秒后指示灯开始闪烁。)

水温降至约为80°C时，温度显示更新，保温指示灯由闪烁转为亮灯。

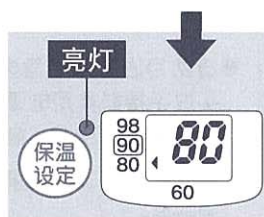

- 根据水量、室温等，有时时间会有变化。
- 想尽快降低水温时，请减少水量。
- 如在水温下降过程中加水，有时无法自动开始沸腾。

60°C保温

热水温度设置为约60°C。

选择“60”

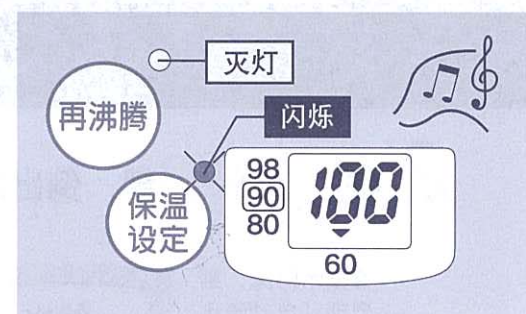

沸腾后响起乐曲报知音，沸腾指示灯灭，保温指示灯闪烁。
(在保温状态下进行设定时，设定60°C保温2秒后指示灯开始闪烁。)

水温降至约为60°C时，温度显示更新，保温指示灯由闪烁转为亮灯。

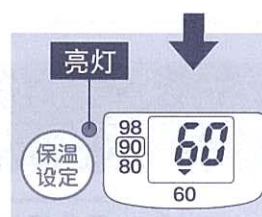

- 根据水量、室温等，有时时间会有变化。
- 想尽快降低水温时，请减少水量。
- 如在水温下降过程中加水，有时无法自动开始沸腾。

电源插头拔下时

- 不慎拔下电源插头时，请将电源插头再次插入。
- 电源插头拔下状态持续数分钟后，再次插入时，有可能会恢复到90°C保温状态，有时会自动开始再沸腾。

沸腾后、
水温变为约80°C、60°C的时间
(室温20°C、最大水量时)

80°C保温 沸腾后，水温变为约80°C的时间	
3.0L时	约1小时10分钟
4.0L时	

60°C保温 沸腾后，水温变为约60°C的时间	
3.0L时	约4小时
4.0L时	

报知音的切换方法 / 滴落式冲泡咖啡

/ 节电定时

报知音的切换方法

1 烧水过程中或保温状态下，
按3秒以上 **锁定解除** 键

- 按键的同时报知音进行切换。
- 出厂设定的报知音为“乐曲报知音”。

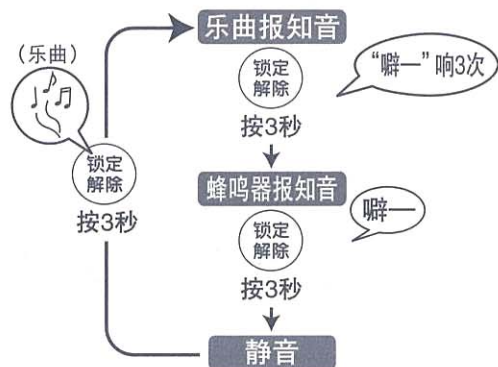

● 乐曲报知音

沸腾后及完成定时设定后，以乐曲报知音或蜂鸣器报知音进行通知的功能。

2 希望切换的声音响了即表示切换完成

- 即便静音，按键时也会有“噼”、“噼噼”或“噼——”声响起。
- 拔掉插头片刻后，报知音的设定将恢复到乐曲报知音。

各模式下报知音的鸣响时间和种类

鸣响时间	模式		
	乐曲报知音	蜂鸣器报知音	静音
完成定时设定时	“美丽的梦仙”	不鸣响	不鸣响
沸腾结束时	“巴哈小步舞曲”	“噼——”响5次	不鸣响

滴落式冲泡咖啡

1 按2次 **锁定解除** 键

滴落式给水指示灯亮灯，变为滴落式给水模式。



2 按 **给水** 键，倒出热水

若指示灯灭，则启动“自动给水锁定”功能。



由于可少量出水（约为通常水量的60%），从而减少热水飞溅，最适合滴落式冲泡咖啡。

- 进入滴落出水模式后，如再按“锁定解除”键，将恢复至普通的出水模式。
- 在滴落式给水指示灯亮灯期间（约60秒）可倒出热水。
- 热水量少时，按“给水”键后稍后才会倒出热水。
- 热水量少时，或者沸腾刚结束时，有时可能会出水不畅。

敬请注意

- 请小心烫伤。
- 冲泡简易型滤泡式咖啡时，请将咖啡袋口牢固地嵌在杯子上，以防止弄翻。
- 在冲泡咖啡时，请倒掉第一杯热水。（第一杯水有可能不够热。）

节电定时

按 **定时** 键，设定希望时间



每按一次键，设定时间将会改变。
6H→7H→8H→9H→10H→（取消）

乐曲报知音响，
节电定时功能自动开始启动。

设定时间结束时，水已沸腾。

乐曲报知音响，沸腾指示灯灭，保温指示灯亮灯。

根据室温、水温、水量，有时会在设定时间之前沸腾。

设定的时间结束后，水已沸腾。
(在节电定时状态下，到开始烧水为止加热器将断电，可节省电费。)

合算

98℃保温时，可节省约30%的电费。
90℃保温时，可节省约25%的电费。

(以每天(24小时)加水二次烧开、再沸腾一次，8小时定时，一年365天使用为基准。)

敬请注意

- 按下电源插头后，节电定时功能即被解除，请重新设定。
- 取消节电定时时，请按数次“定时”键，或者按1次“再沸腾”键。

清理

清洗本体前请务必拔掉电源插头，倒掉剩余热水并待本体冷却后进行。

敬请注意

- 请勿在底部潮湿的状态下将本品倒置晾干。（内部一旦进水会引发故障或生锈。）
- 请勿使用稀释剂、汽油、去污粉、刷子（尼龙、金属刷等）、漂白剂等清洗。（会损伤防粘涂层）
- 请勿使用洗碗烘干机、餐具烘干机。（会造成树脂变形）
- 长时间不使用时，为避免留有异味，请充分晾干后放入塑料袋中保管。

内盖 用柔软的湿海绵擦拭

内容器 定期进行柠檬酸清洗 →P.15

出现以下情况时，请进行柠檬酸清洗。

- 有红色锈状斑点(由其他物质产生的锈)
- 出现乳白色、黑色等变色，漂浮着薄膜状杂质
- 水沸腾时，会发出较大的声响
- 热水有异味

(内容器的污垢程度根据使用水质和烧水次数而不同。)

容器网 从内容器中拆下，用刷子清洗

往上一拉就能取出。安装时用力按压固定好。

污垢无法去除时，请更换容器网。

- 请务必安装好容器网后使用。（否则，一旦异物进入电动泵内，会造成热水无法倒出）

电源线 用干抹布擦拭污垢

本体、上盖 用拧干水分的湿抹布擦拭污垢

- 请勿将本品整个清洗或让操作面板溅上水。（内部一旦进水，会引起故障或生锈）

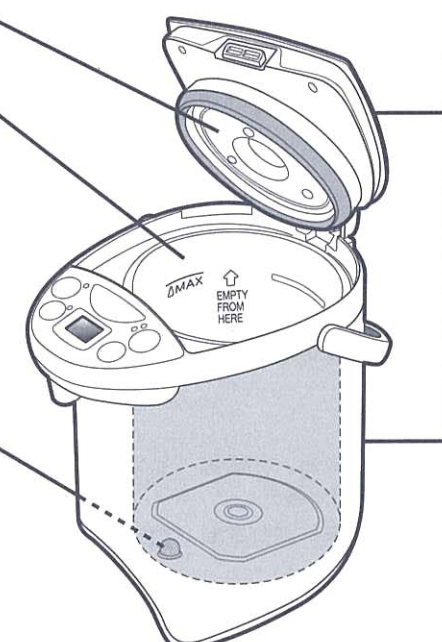

更换内盖垫圈

内盖垫圈为易耗品。请每年检查一次。

请用浸湿的柔软的海绵擦拭后，再安装新内盖垫圈。

拆卸方法

- ① 取下3个螺丝钉，拆下内盖
 - 请勿将螺丝钉遗失。
- ② 拆下装在内盖上的内盖垫圈

拆下内盖后，请确认上盖的树脂部分有没有异常。→变色或表面粗糙的话，请更换(有偿)。

安装方法

- ① 将内盖垫圈按图示嵌入内盖外围中
- ② 把上盖的定位点和内盖的小孔的位置对准，确实拧紧3个螺丝钉

当内盖垫圈颜色变白时，如倾斜或不慎翻倒，热水可能从上盖和本体的缝隙间流出，有烫伤的危险。更换内盖垫圈后还是蒸汽泄漏或热水溢出时，可能有其他零配件的损坏，请咨询本公司的客户服务中心。

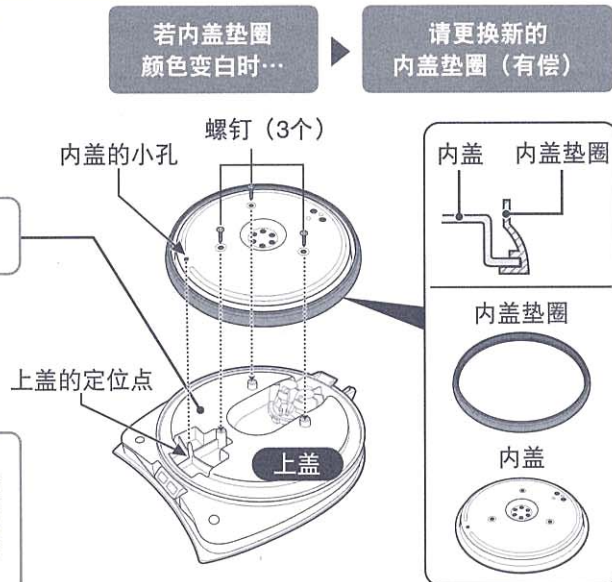

每1~3个月清洗1次

柠檬酸清洗方法

敬请注意 为防止起泡、溢出，请使用本公司的热水瓶内容器清洗用柠檬酸（另售）。请参阅以下说明。

准备 确认容器网是否已安装好



敬请注意

- 容器网附着污垢后，请将其从内容器上拆下，用刷子清洗后再装回。

1 将柠檬酸（CD-K03E-JU）1包放入杯中，用温水溶化开，然后在内容器中倒入柠檬酸溶液，并加水至最大水量标示

敬请注意

- 加水时请勿超过最大水量标示。（否则会溢出）

2 盖好上盖，插入电源插头，按 **再沸腾** 键3秒以上

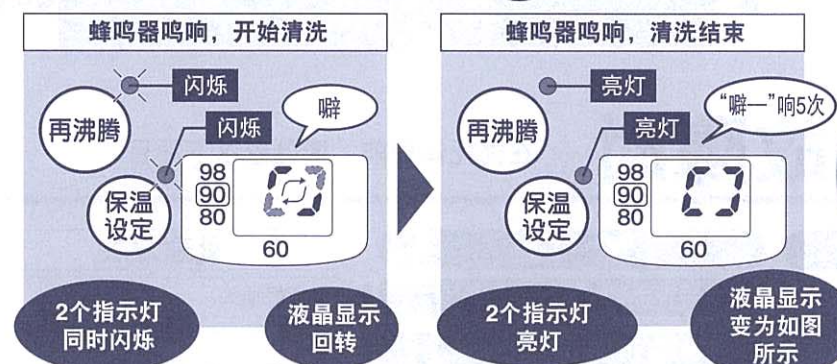

清洗时间
约1小时30分钟*

*清洗时间根据水量、水温、室温等略有不同。

3 拔掉电源插头，卸下上盖，从倒水位置把热水倒净
(倒水时请注意不要让水溅到铰链部位。)

敬请注意

- 污垢难以去除和出水不顺畅时，请反复使用柠檬酸清洗。

4 仅将水烧开，经注水口流出一杯热水后，倒掉剩余热水
(为清洗内容器及注水口内部)

- 使用矿泉水或碱性离子水时，内容器和容器网容易粘附钙质等污垢。另外，当内容器和容器网粘附水垢等污垢而放置不理时，会使烧水中声音增大，出水不顺畅。使用矿泉水或碱性离子水时，请勤加清洗。

倒热水时

- 请注意倒掉的热水和蒸汽。（否则会导致烫伤）
- 请注意注水口的热水滴。（否则会导致烫伤）

中途停止柠檬酸清洗时，拔掉 **电源插头5秒钟以上**。

更换零件

- 出现损坏时，请更换新的零件（有偿）。
- 如需购买，请确认好产品的型号，请至购买处的经销店购买。

零件名称	零件编号
内盖垫圈	62-5702
容器网	62-7402
热水瓶内容器清洗用柠檬酸 (30g×4包装)	CD-K03E-JU

可以加入水以外的其他物品吗?	请勿放入除水以外的其他东西, 以免引发故障或因放入物的溢出而造成烫伤。	P.2 P.3
必须每天换水吗?	由于会造成水垢附着, 建议每天倒掉剩余热水。	P.8
可以使用矿泉水吗?	如使用矿泉水, 有时水面会有细小漂浮物或内容器上附着乳白色粗糙物, 这是水质成分(矿物质), 并非有害物质。	P.7
可以使用碱性离子水吗?	如使用碱性离子水, 内容器易附着钙质。请经常进行清洗。	P.15
不慎喝入了正在柠檬酸清洗时的热水!!	请按照柠檬酸清洗剂外包装所记载的内容进行。	
在电热水瓶的电源处于接通状态时是否可以外出?	万一水没了时, 防空烧功能(加热器断电)自动启动, 请放心。	P.9

认为发生故障时

在委托修理前, 请检查以下项目。

	现象	原因	处理方法
烧水	水不开	插头是否脱落?	请插好插头。
	热水有异味	内容器是否附着水垢?	请使用柠檬酸清洗内容器。
		是否有进行清理(柠檬酸清洗)?	
	长时间没有使用。	水烧开后按“给水”键, 流出1L左右的热热水后, 倒出剩余热水后再使用。→P.7	
		<ul style="list-style-type: none"> 刚开始使用时, 可能会有塑料等异味, 随着使用次数的增加会逐渐消失。 有时会残留自来水中的消毒氯气(漂白粉)的味道。 	
	热水从注水口或蒸汽口自动流出	加水是否超过了最大水量标示?	水量保持在最大水量标示以下。
	热水不够热	刚沸腾后或长时间未注水使用时, 有时热水可能会不够热。请将第一杯热水到掉。	
注水	热水流不出或流出不顺畅	沸腾后数分钟内, 有时热水流出不畅。	打开一次上盖, 排出气泡后盖好上盖。(请小心蒸汽)
		内容器和容器网是否附着水垢?	请清洗内容器和容器网。→P.14
		是否处于自动给水锁定状态?	按 再沸腾 键后, 再按 给水 键。→P.8
		插头是否脱落?	请插入插头。
		注水管路内附着水垢时, 有时会出水不顺畅。	请使用柠檬酸清洗内容器。→P.15

	现象	原因	处理方法
保温	热水中漂浮着薄膜状杂质(是不是防粘涂层脱落了?)	这是水中的矿物质成分所致, 并非内容器被腐蚀或防粘涂层脱落。	请使用柠檬酸清洗内容器。→P.15
	内容器附着有乳白色的粗糙物(烧水时声音很大)	内容器上附着的水垢等污垢如不及时清理, 烧水时声音会变大。	<div style="border: 1px solid black; padding: 5px;"> <p style="text-align: center;">水垢</p> <p>在使用过程中, 水中含有的钙质等矿物质会附着在内容器和容器网上。这就是通常所说的“水垢”, 并非有害物质。</p> </div>
	内容器附有红色锈状斑点	这是水中的铁质成分所致, 并非内容器被腐蚀。	
	热水中漂浮着白色的杂质	拆下内盖, 请确认上盖的树脂部分有没有异常。	变色或表面粗糙的话, 请更换(有偿)。→P.14
	热水不够热	是否设定为节电“定时”?	按 再沸腾 键。→P.9

出现以下显示时

蜂鸣器报警, 指示灯亮灯, 液晶如图所示

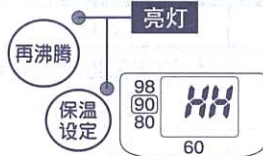

因水少或加入热水而使防止干燥功能启动。→P.9

拔下电源插头, 待内容器充分冷却后加水, 然后再插上电源插头。

2个指示灯同时闪烁, 液晶显示回转

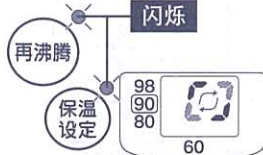

正在柠檬酸清洗过程中。→P.15

要停止柠檬酸清洗时, 请拔下电源插头并等待5秒以上, 然后再插上插头。

液晶显示 $E3 \cdot E4$ 是故障。请咨询购买本品的经销店或本公司的客户服务中心。

上盖的消耗	其他
内盖垫圈	本体发热
树脂部分	电源线发热
	打开或盖上上盖时, 会听到“喀喇喀喇”的声音
	显示面板模糊

内容器(防粘涂层)有时会随着使用而出现损伤。请咨询购买本品的经销店或本公司的客户服务中心。

规格

型号		CD-WBH30C	CD-WBH40C
额定容量		3.0L	4.0L
电源		交流220V 50Hz	
消耗功率		640W	
保温时平均耗电量	98℃	约45W	约51W
	90℃	约38W	约44W
	80℃	约31W	约36W
	60℃	约18W	约21W
电源线长度		1.8m	
外形尺寸(约cm)		宽21×深28.5×高29	宽21×深28.5×高34
重量(含电源线)		约2.4kg	约2.5kg

型号		CD-WBQ22	CD-WBQ30	CD-WBQ40
额定容量		2.2L	3.0L	4.0L
电源		交流220-230V 50/60Hz		
消耗功率		640-700W		
保温时平均耗电量	98℃	约38W	约45W	约51W
	90℃	约33W	约38W	约44W
	80℃	约26W	约31W	约36W
	60℃	约15W	约18W	约21W
电源线长度		0.75m		
外形尺寸(约cm)		宽21×深28.5×高25	宽21×深28.5×高29	宽21×深28.5×高34
重量(含电源线)		约2.1kg	约2.3kg	约2.5kg

- 保温时平均耗电量指在室温20℃时对最大水量进行保温的情况下每小时的耗电量。
- 高度为放下手柄时的尺寸。
- 在特定地区(高山、严寒地带),部分功能可能无法正常运转。请尽量避免在这些地区使用。